

LEGO DIGITAL DESIGNER 4.2

Model Name:
Tram HTM 265 -12-set
Number of Bricks: 435

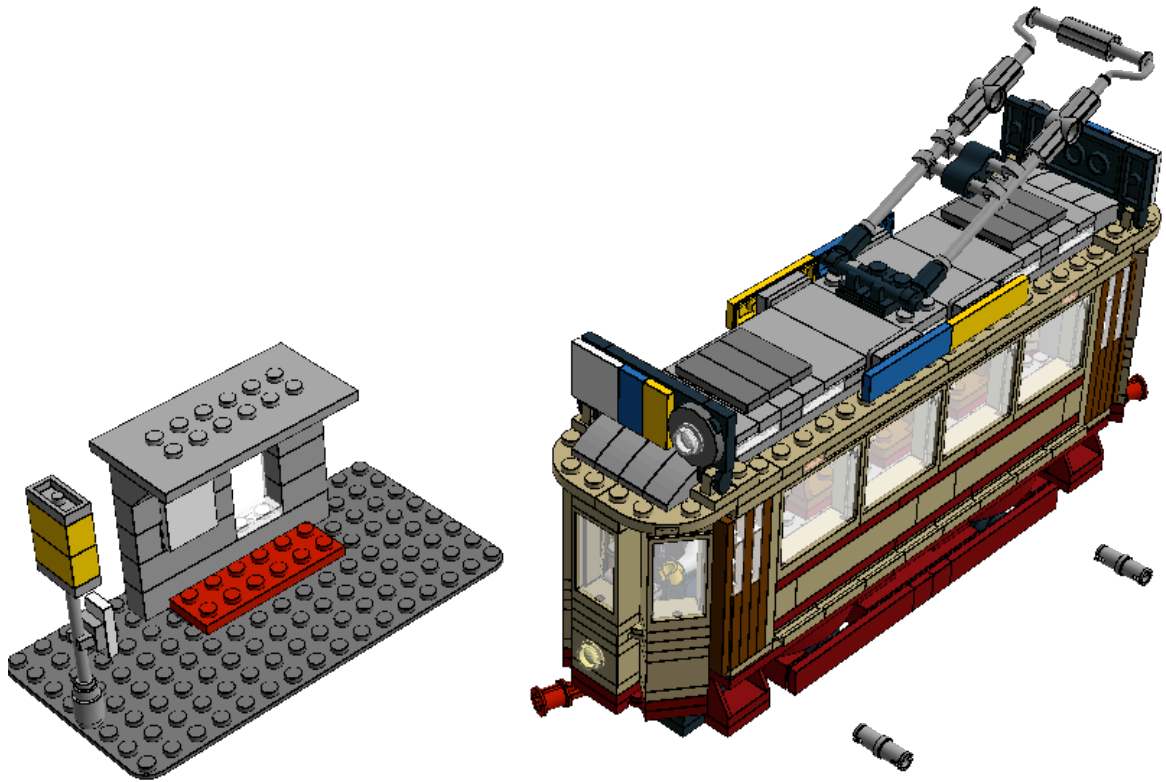

Step 1 of 149

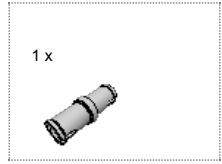

Step 2 of 149

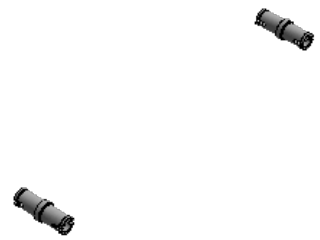

Step 3 of 149

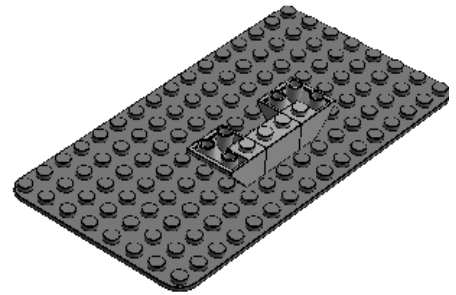
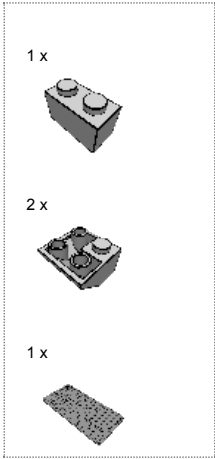

Step 4 of 149

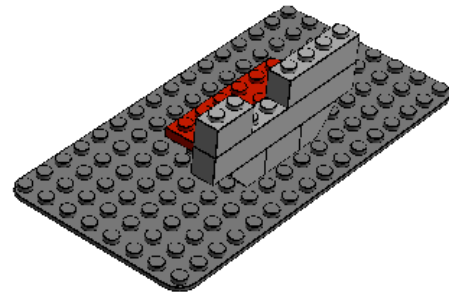
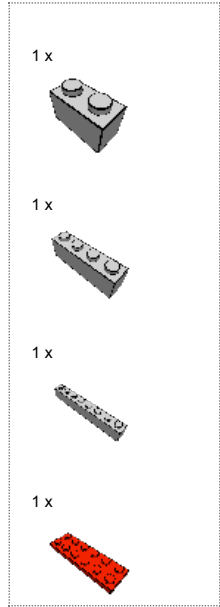

Step 5 of 149

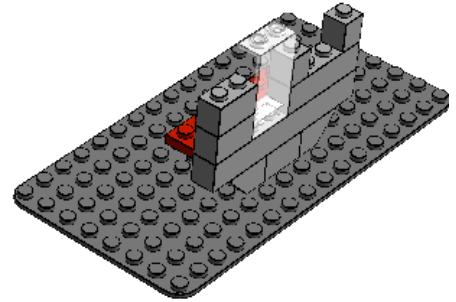
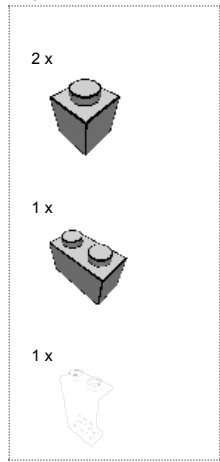

Step 6 of 149

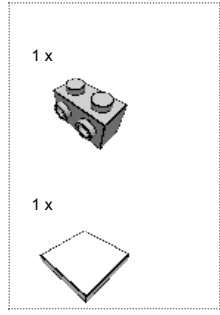

Step 7 of 149

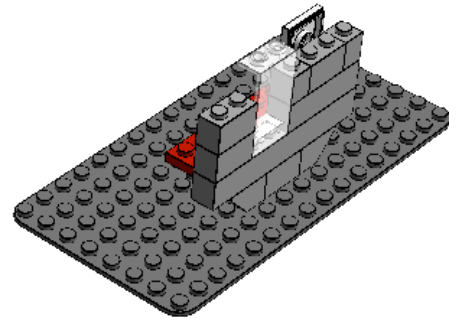

Step 8 of 149

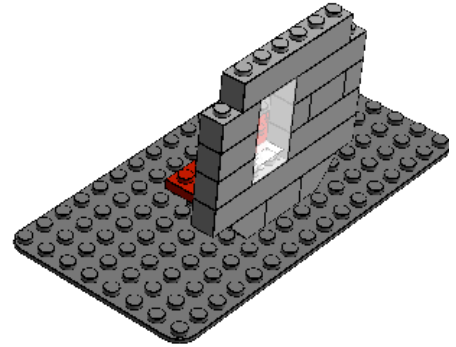
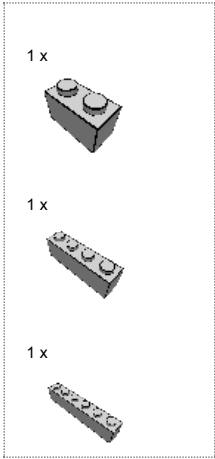

Step 9 of 149

2 x



1 x

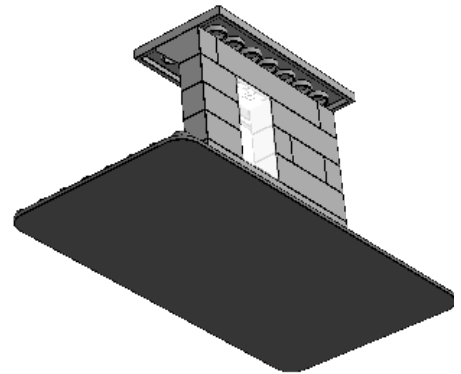

Step 10 of 149

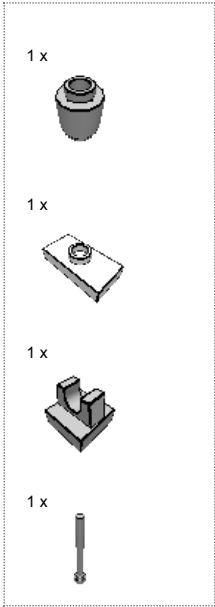

Step 11 of 149

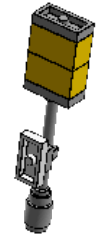
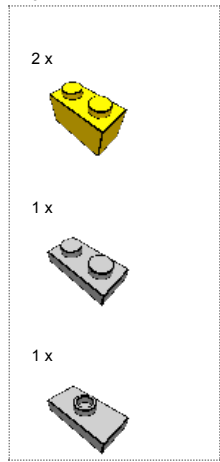

Step 12 of 149

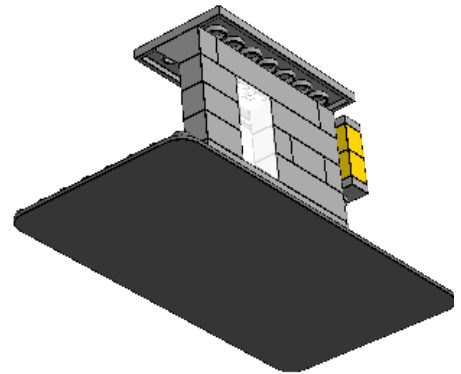

Step 13 of 149

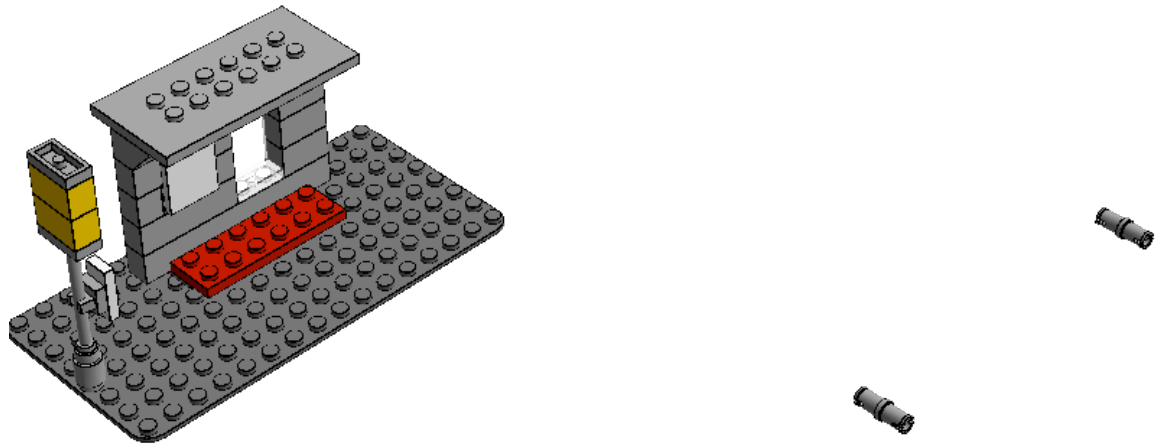

Step 14 of 149

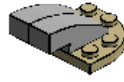
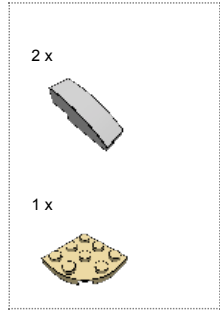

Step 15 of 149

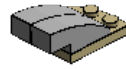
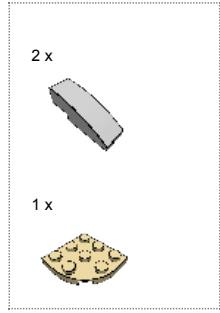

Step 16 of 149

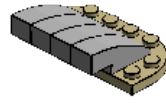

Step 17 of 149

2 x



1 x



1 x

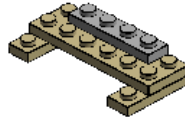

Step 18 of 149

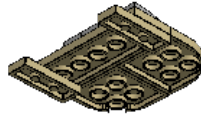

Step 19 of 149



Step 20 of 149

1 x



1 x



1 x



1 x

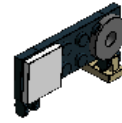

Step 21 of 149

1 x



1 x



1 x



1 x

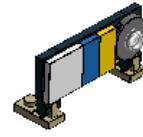

Step 22 of 149

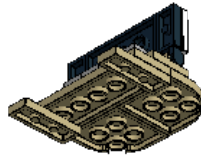

Step 23 of 149

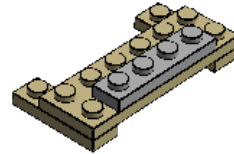
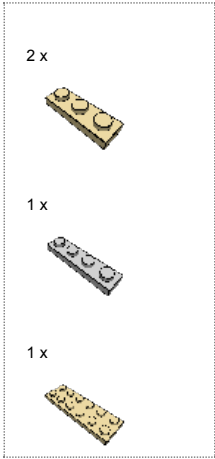

Step 24 of 149

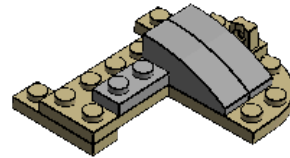
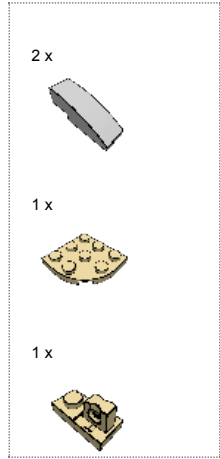

Step 25 of 149

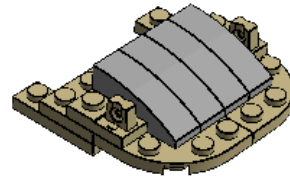
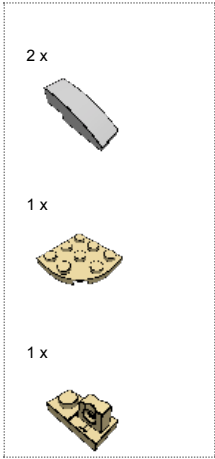

Step 26 of 149

1 x



1 x



1 x



1 x

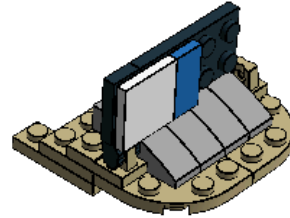

Step 27 of 149

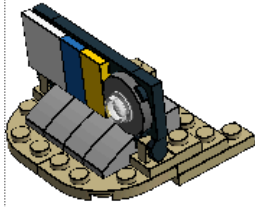
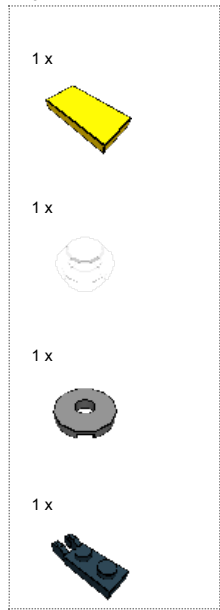

Step 28 of 149

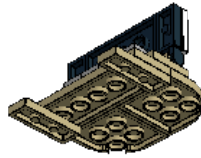

Step 29 of 149

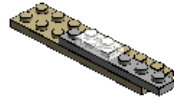
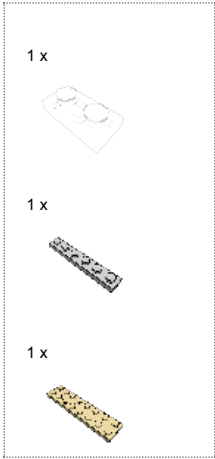

Step 30 of 149

1 x



1 x



1 x



1 x

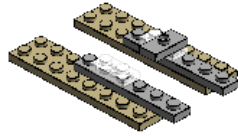

Step 31 of 149

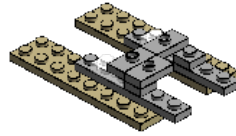
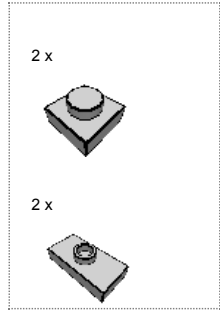

Step 32 of 149

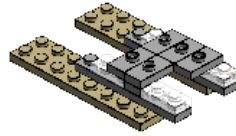
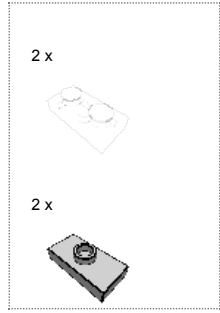

Step 33 of 149

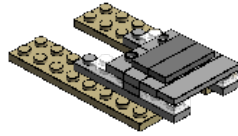
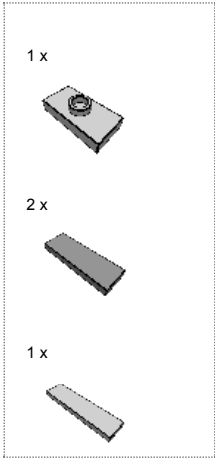

Step 34 of 149

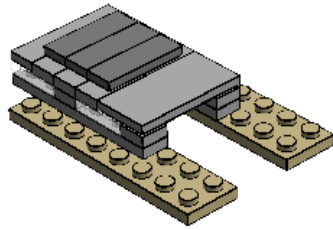
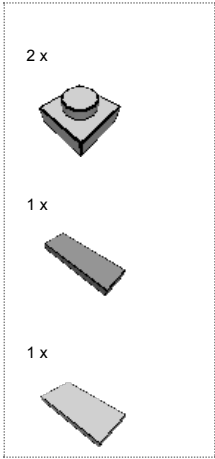

Step 35 of 149

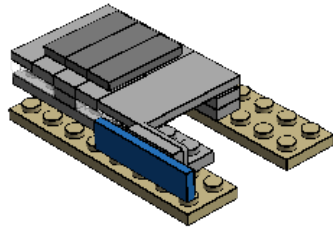
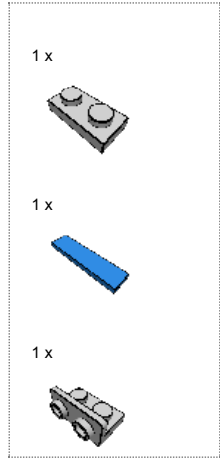

Step 36 of 149

1 x



1 x



1 x



1 x

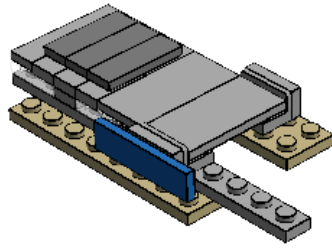

Step 37 of 149

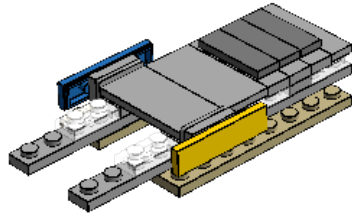
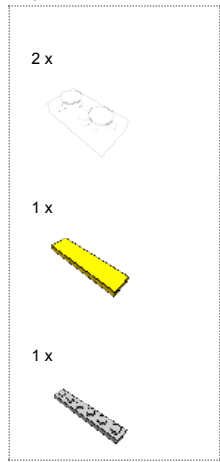

Step 38 of 149

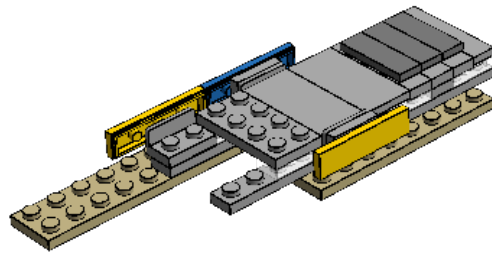
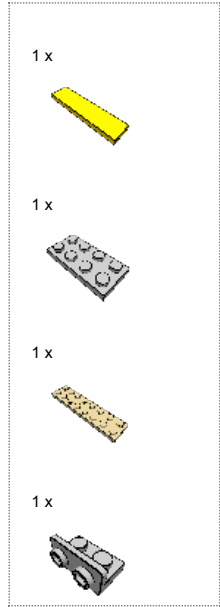

Step 39 of 149

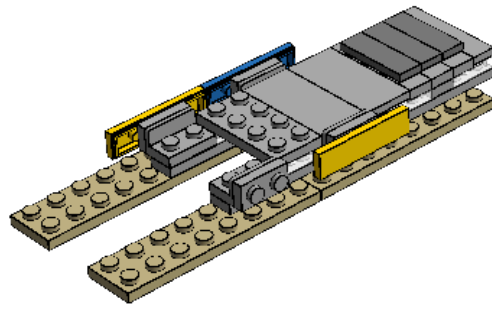
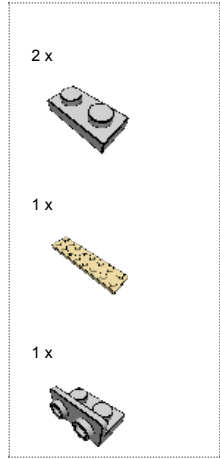

Step 40 of 149

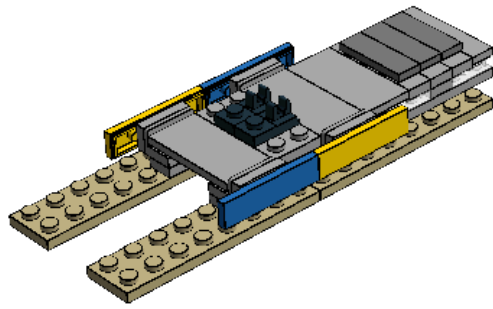
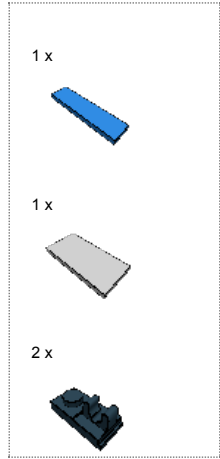

Step 41 of 149

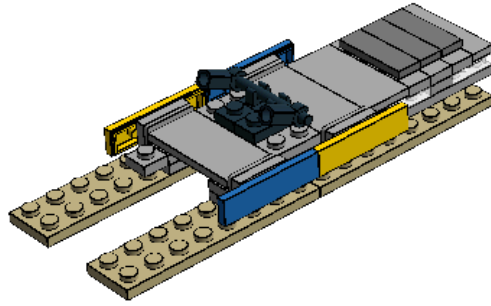
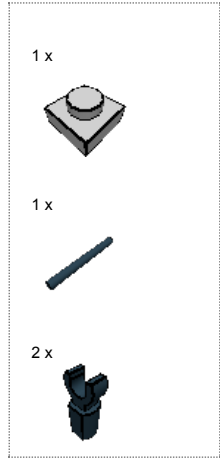

Step 42 of 149

1 x



1 x



1 x



1 x

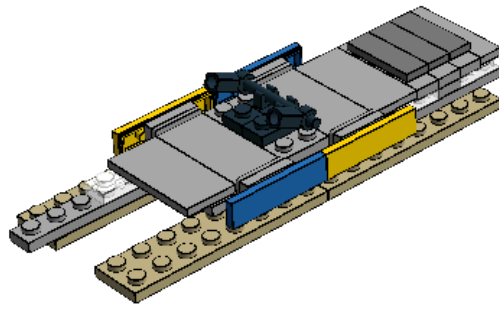

Step 43 of 149

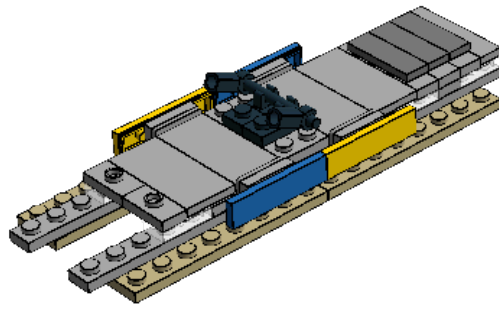
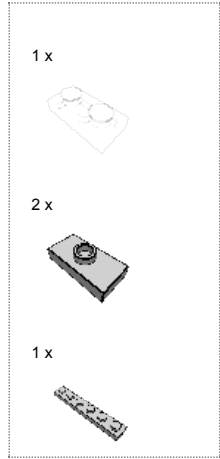

Step 44 of 149

2 x



1 x



1 x

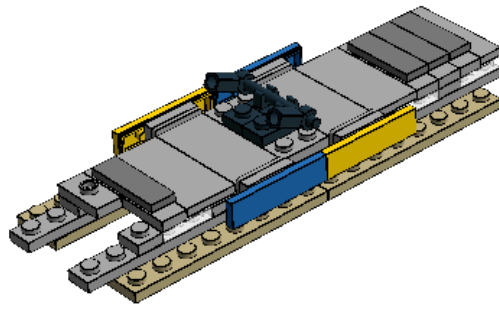

Step 45 of 149

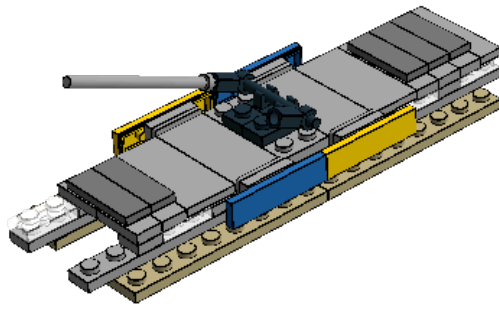
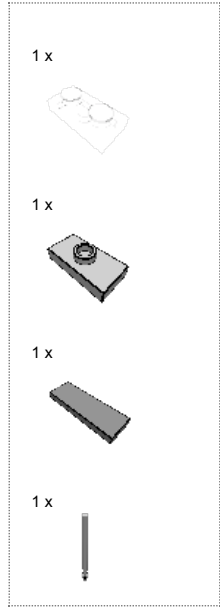

Step 46 of 149

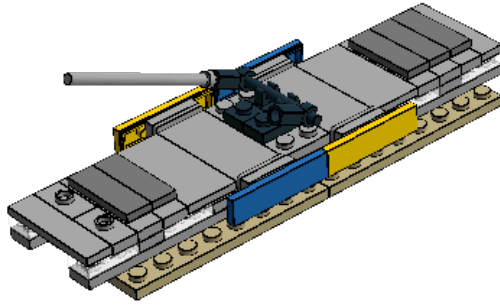
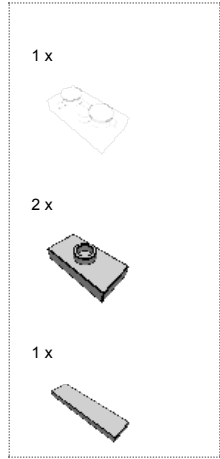

Step 47 of 149

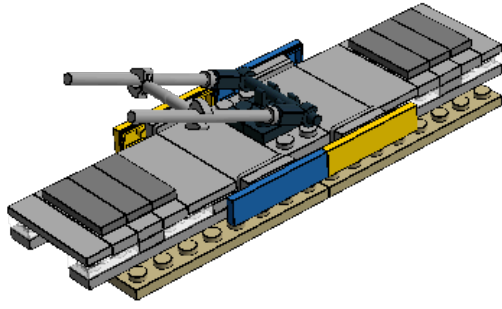
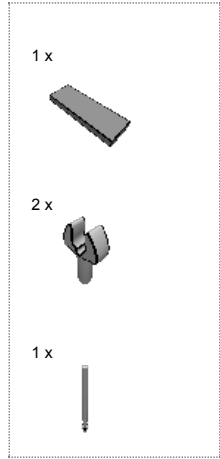

Step 48 of 149

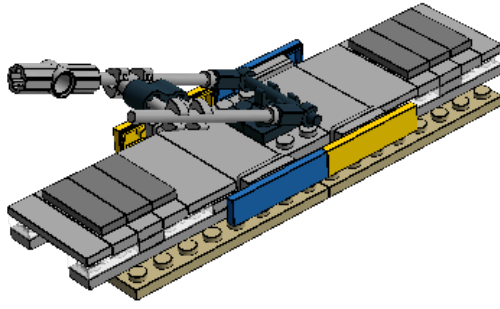
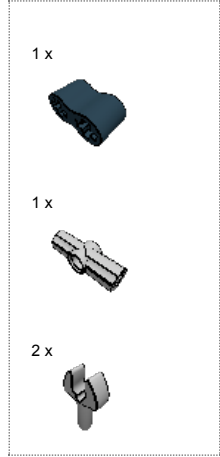

Step 49 of 149

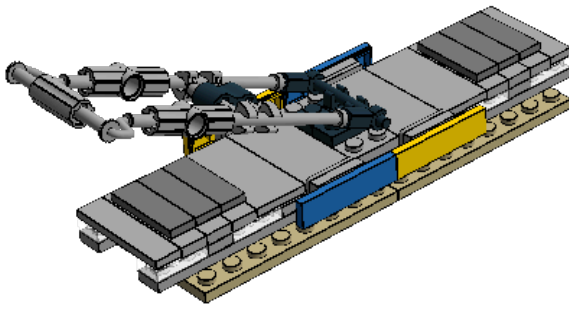
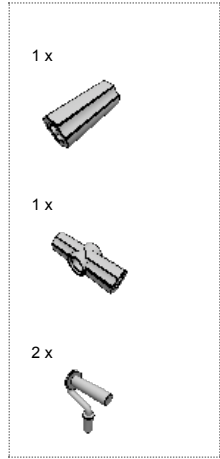

Step 50 of 149

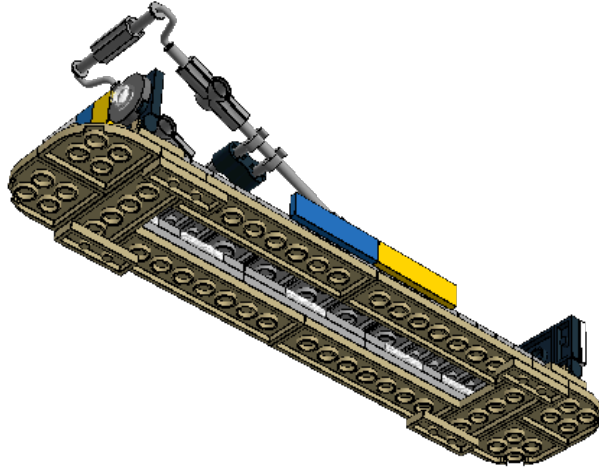

Step 51 of 149

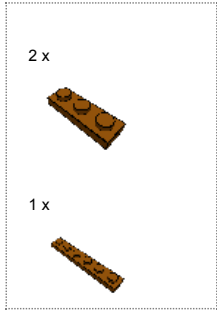

Step 52 of 149

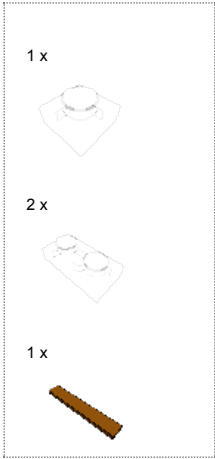

Step 53 of 149

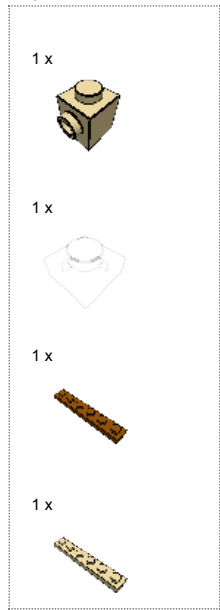

Step 54 of 149

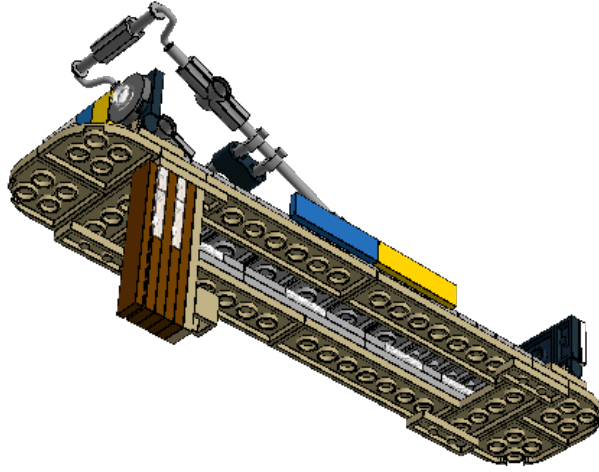

Step 55 of 149

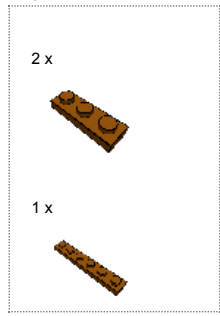

Step 56 of 149

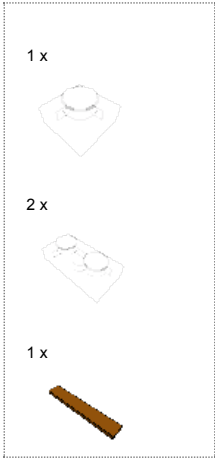

Step 57 of 149

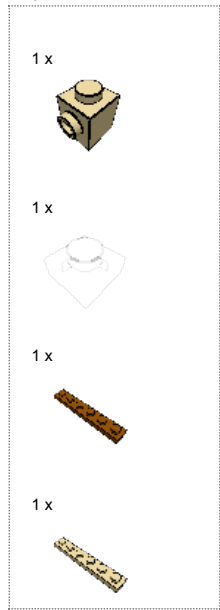

Step 58 of 149

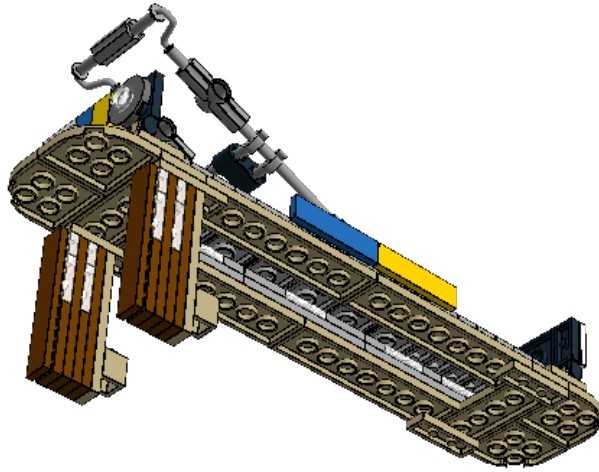

Step 59 of 149

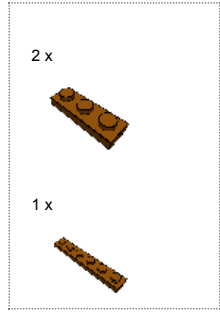

Step 60 of 149

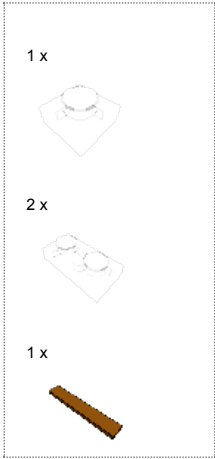

Step 61 of 149

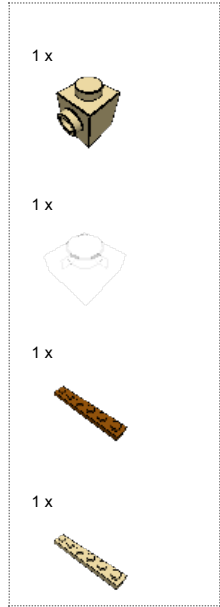

Step 62 of 149

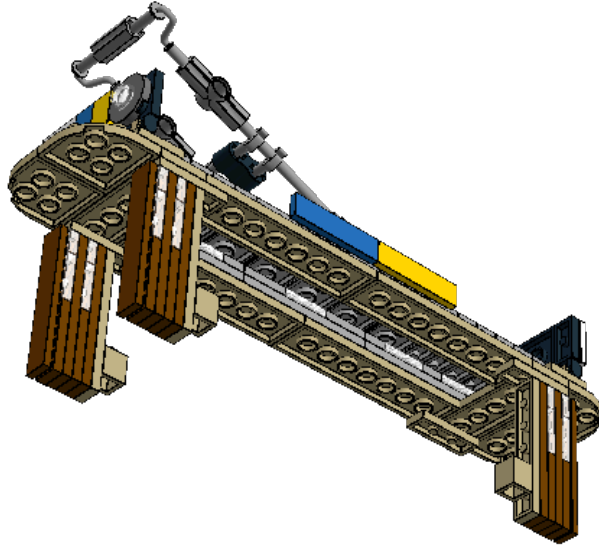

Step 63 of 149

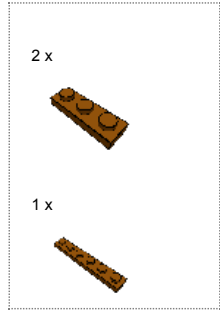

Step 64 of 149

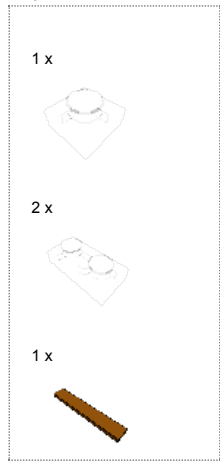

Step 65 of 149

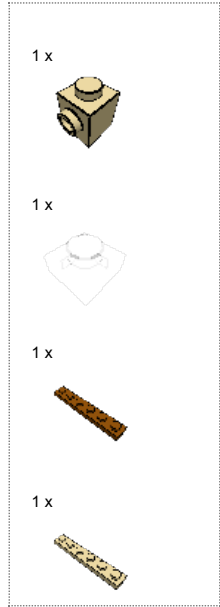

Step 66 of 149

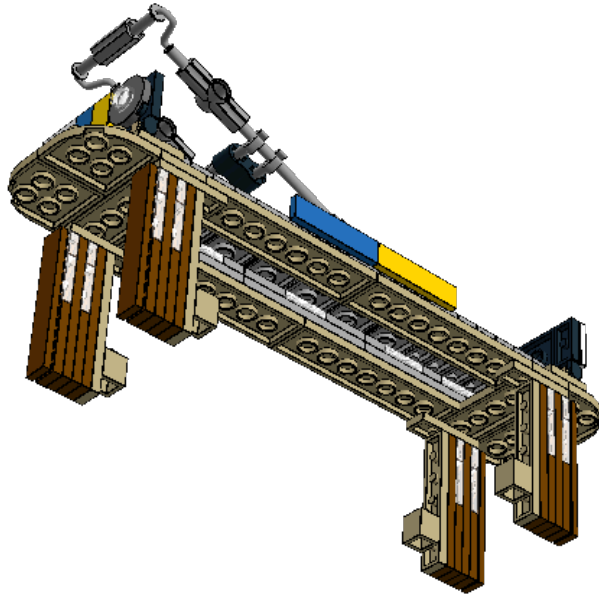

Step 67 of 149

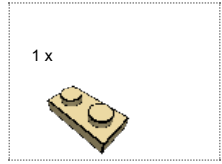

Step 68 of 149

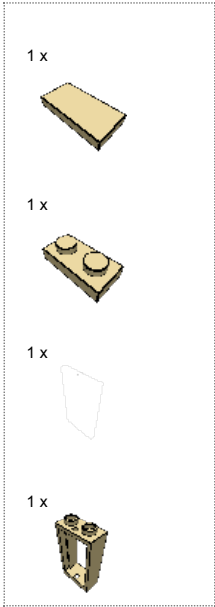

Step 69 of 149

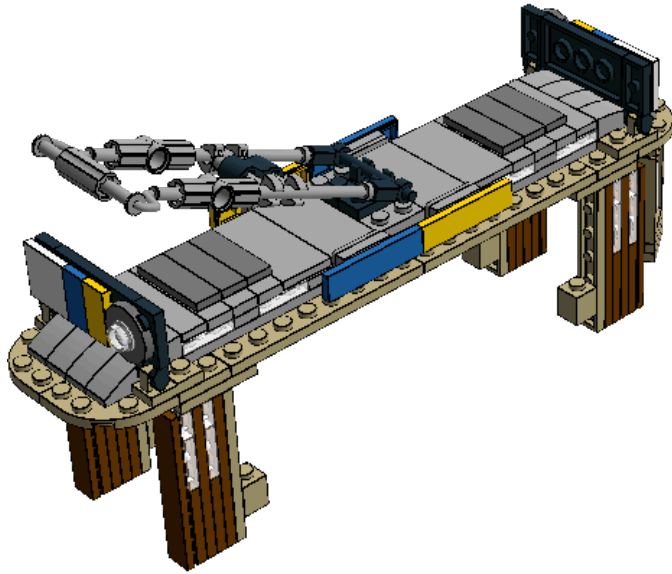

Step 70 of 149

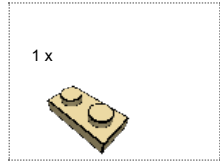

Step 71 of 149

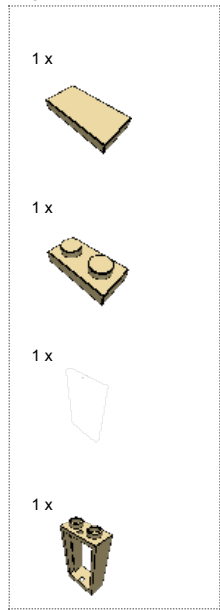

Step 72 of 149

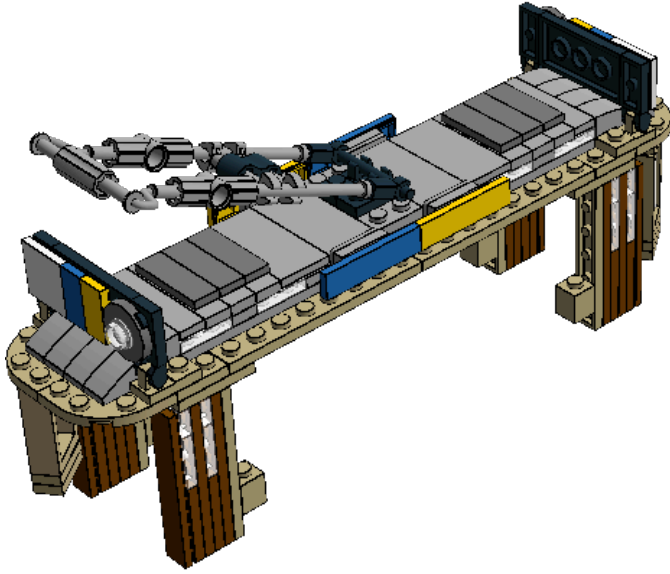

Step 73 of 149

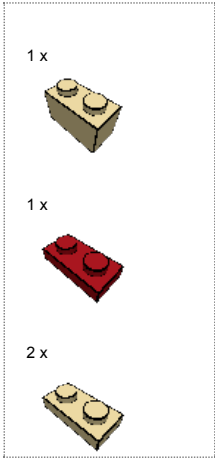

Step 74 of 149

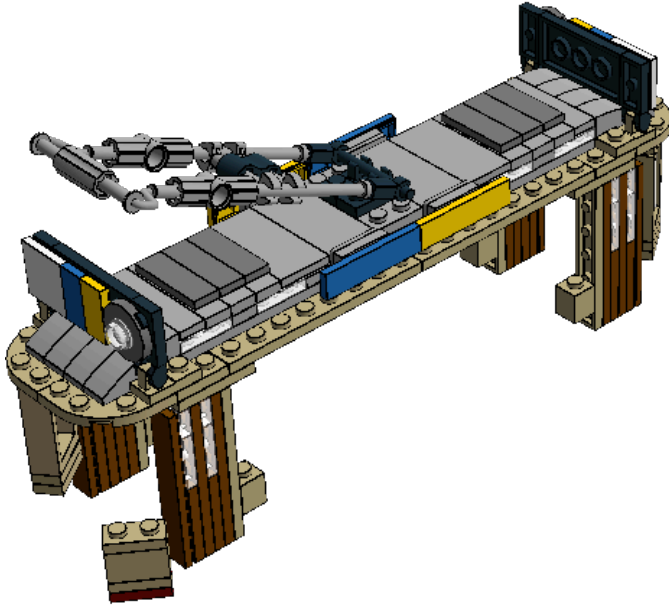

Step 75 of 149

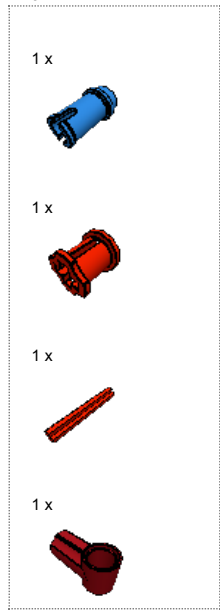

Step 76 of 149

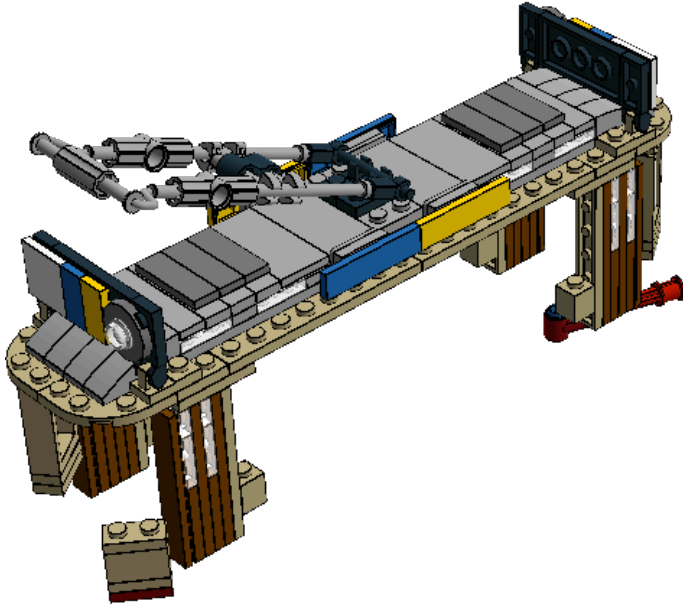

Step 77 of 149

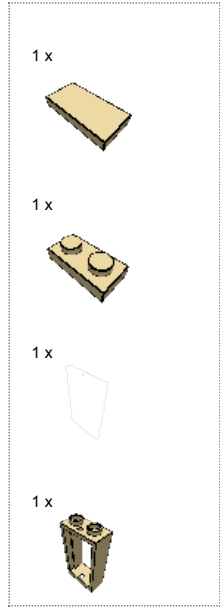

Step 78 of 149

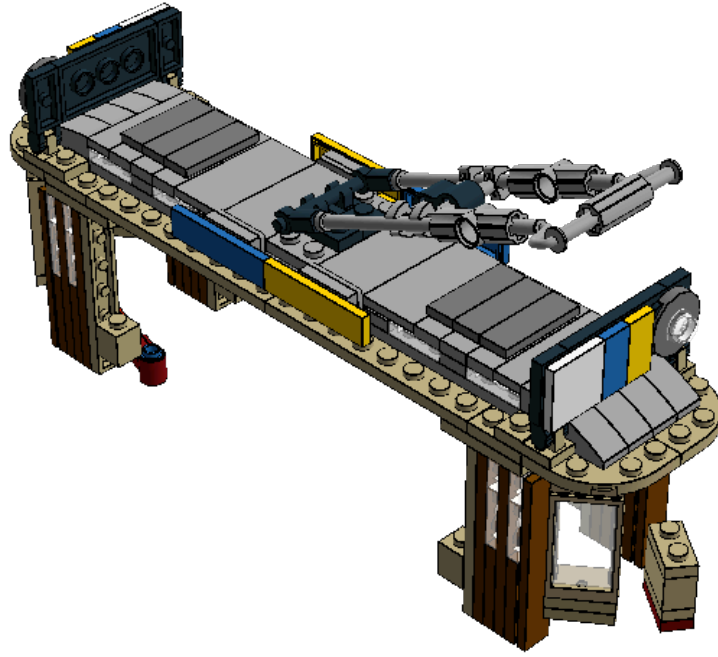

Step 79 of 149

1 x



1 x



1 x



1 x



Step 80 of 149

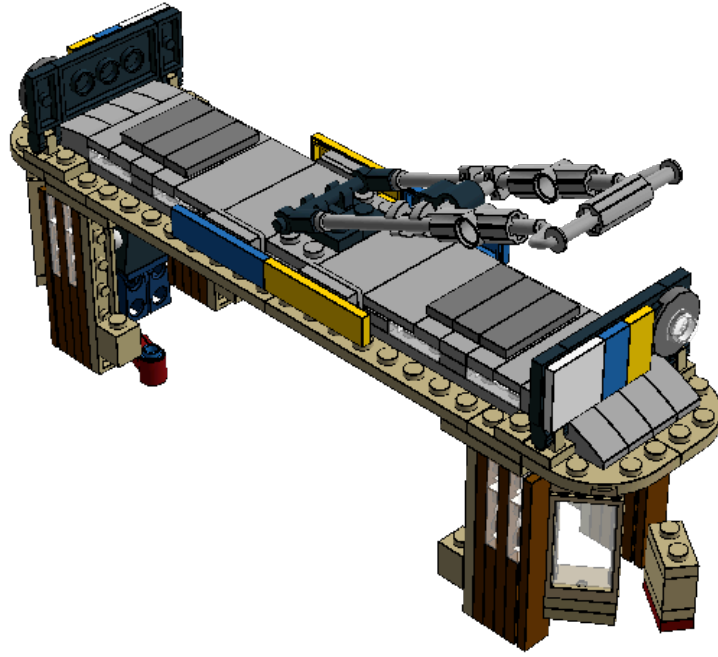

Step 81 of 149

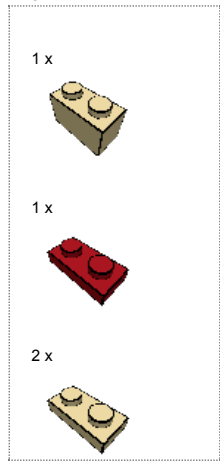

Step 82 of 149

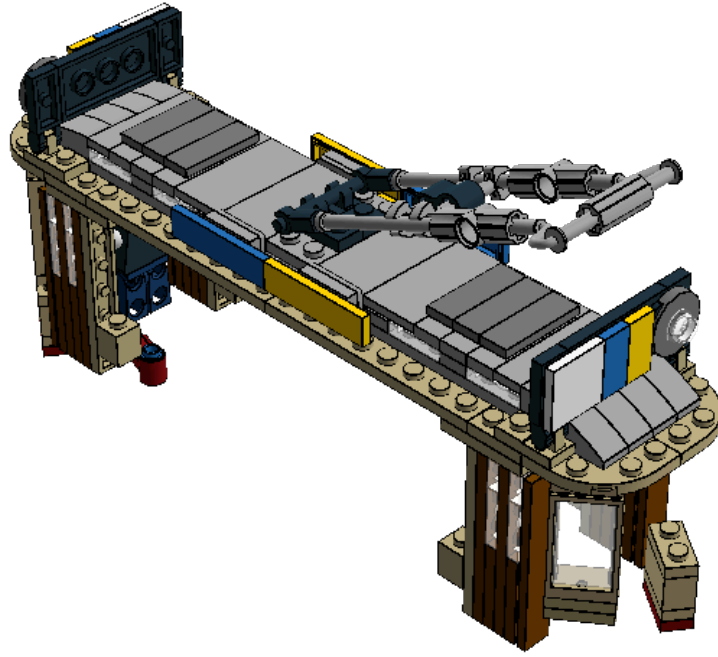

Step 83 of 149

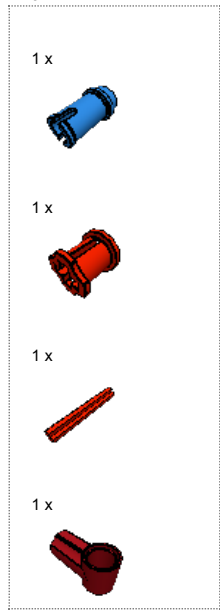

Step 84 of 149

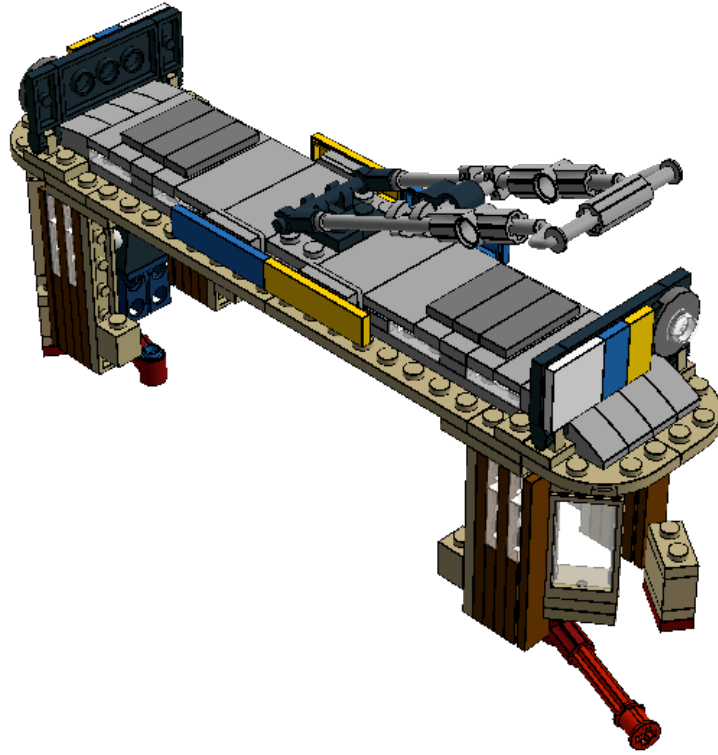

Step 85 of 149

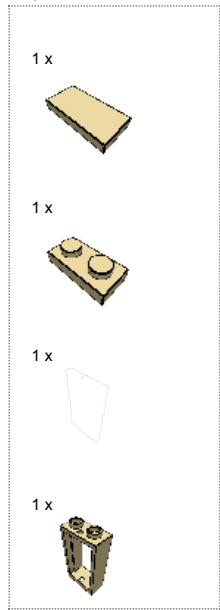

Step 86 of 149

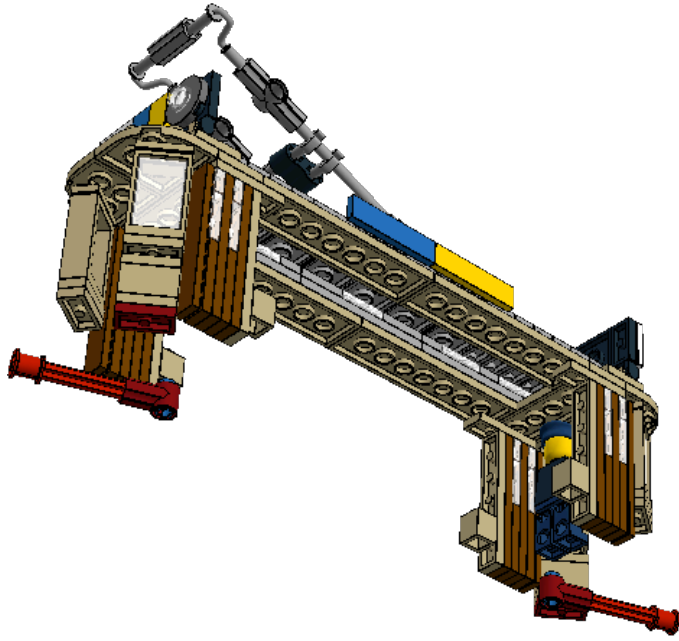

Step 87 of 149

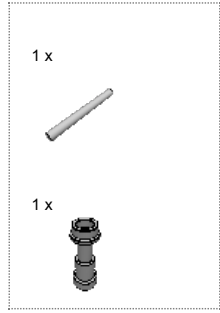

Step 88 of 149

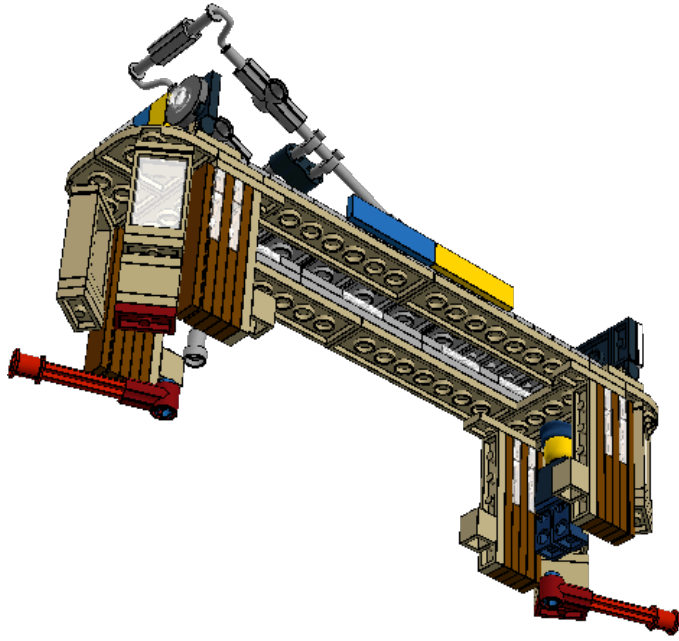

Step 89 of 149

2 x



Step 90 of 149

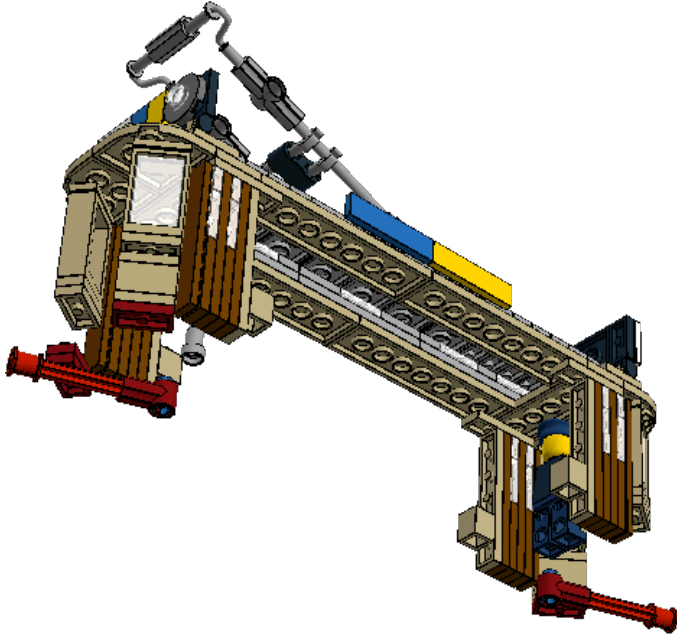

Step 91 of 149

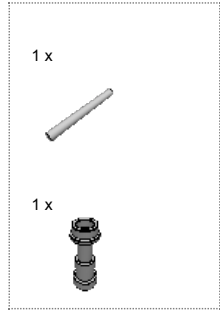

Step 92 of 149

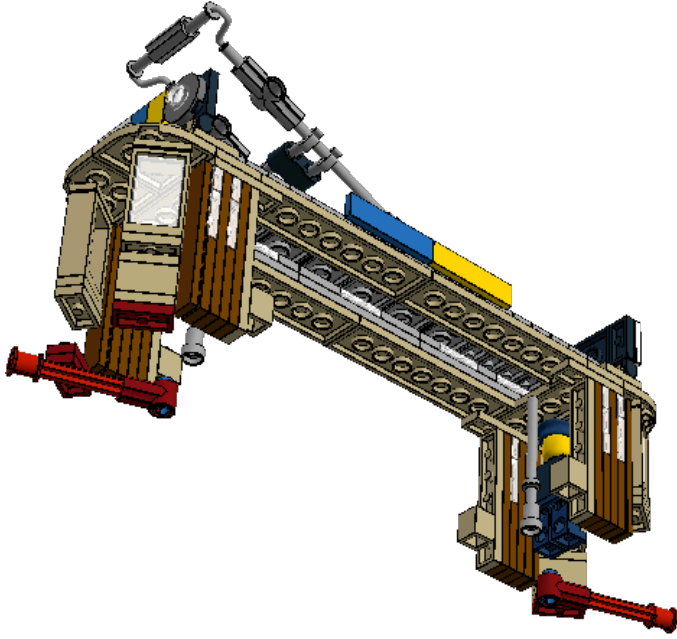

Step 93 of 149

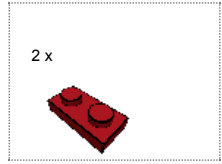

Step 94 of 149

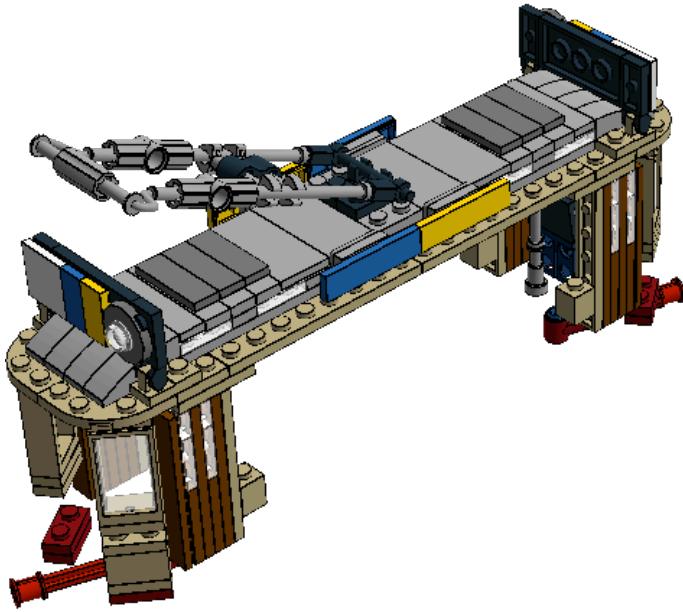

Step 95 of 149

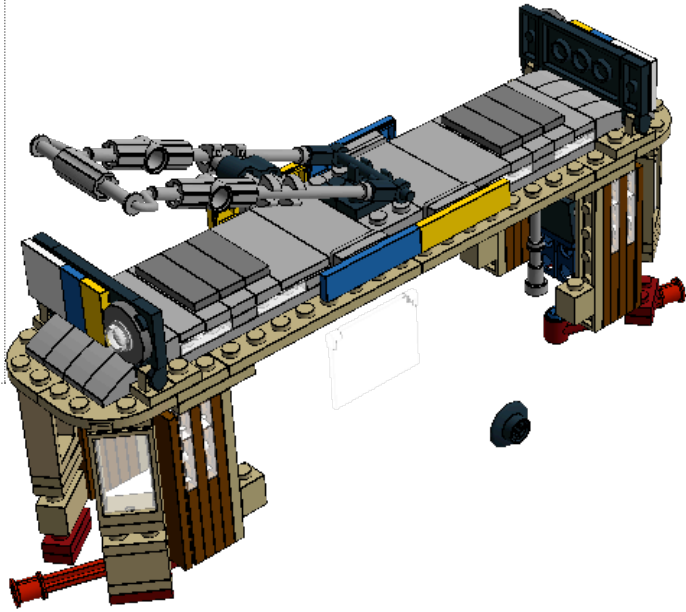
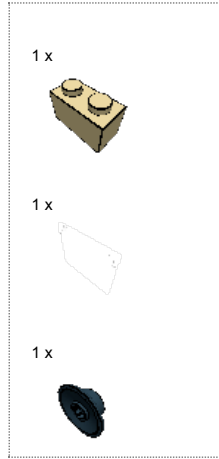

Step 96 of 149

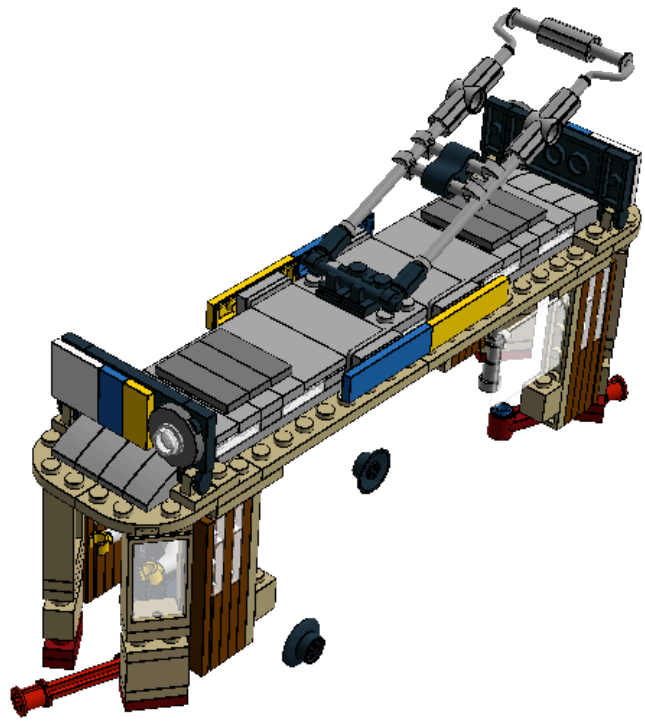
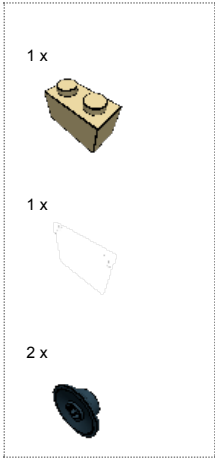

Step 97 of 149

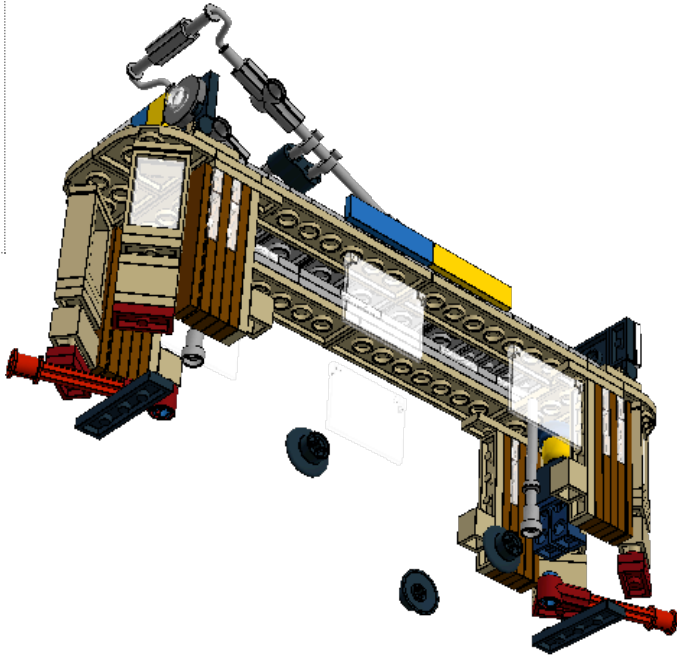
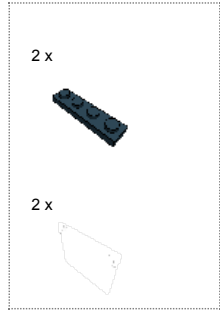

Step 98 of 149

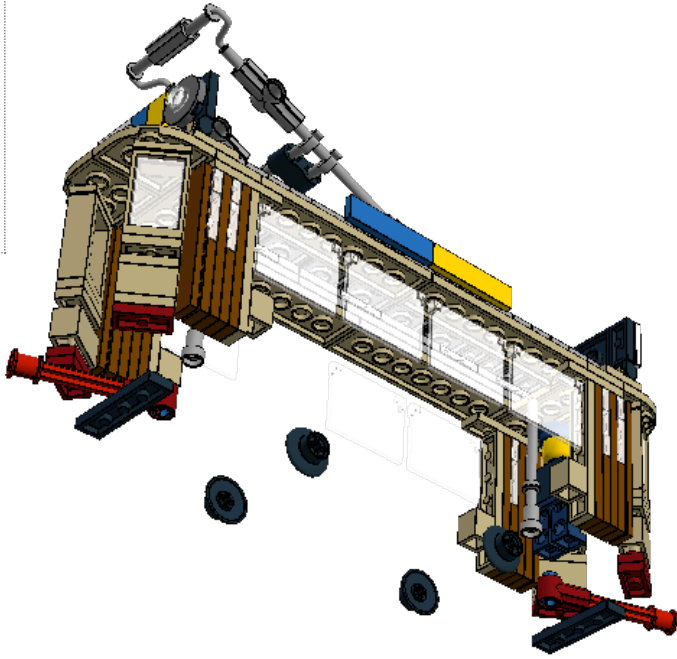
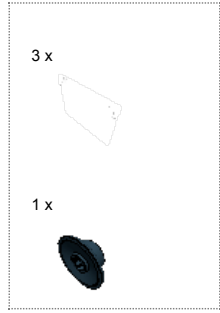

Step 99 of 149

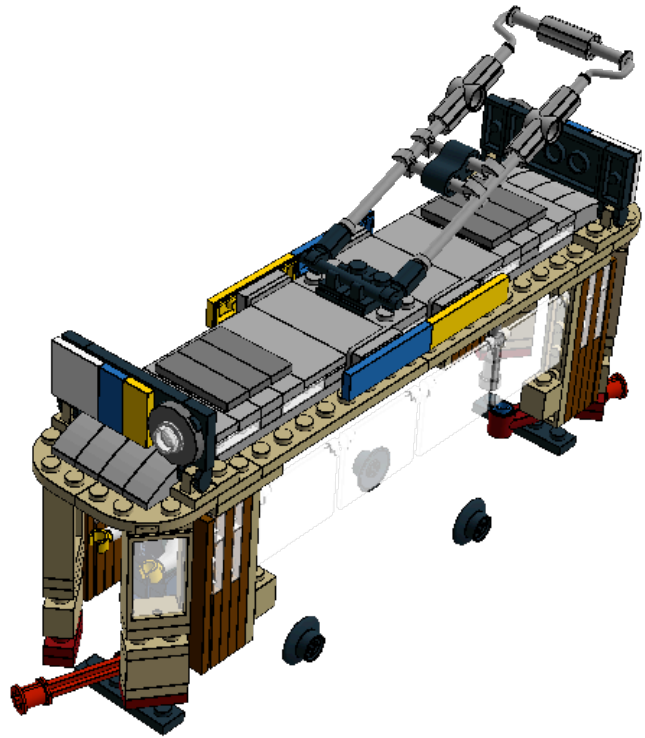
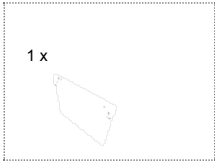

Step 100 of 149

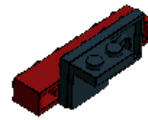
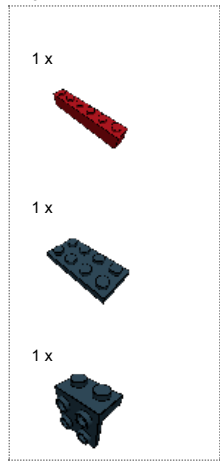

Step 101 of 149

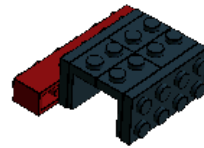
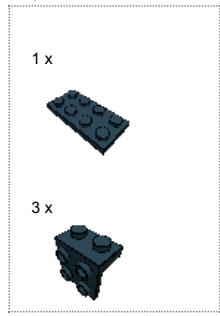

Step 102 of 149

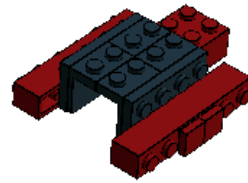
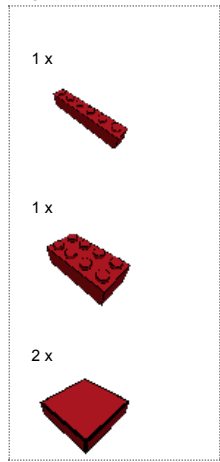

Step 103 of 149

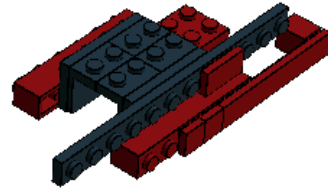
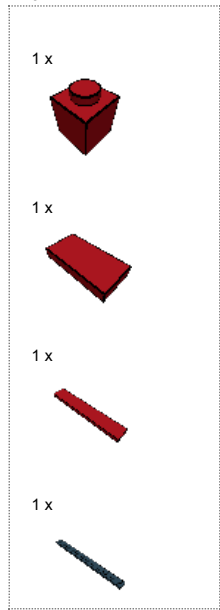

Step 104 of 149

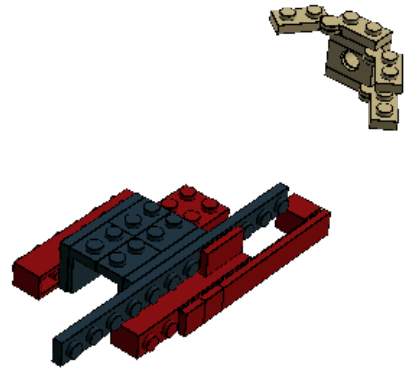
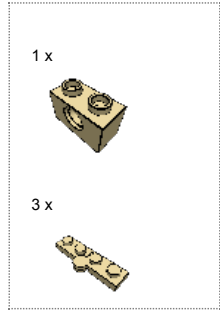

Step 105 of 149

1 x



1 x



1 x



1 x

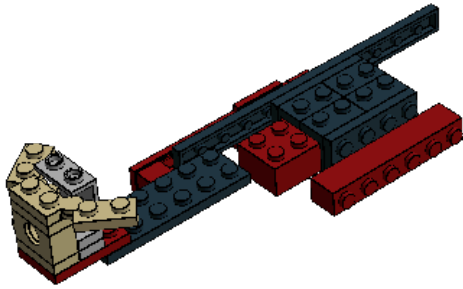

Step 106 of 149

1 x



1 x



1 x



1 x

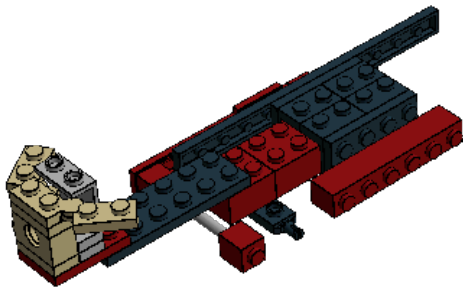

Step 107 of 149

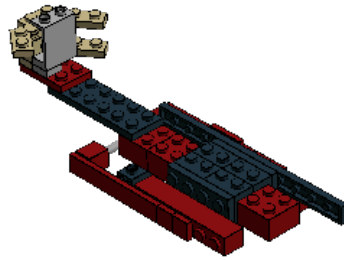
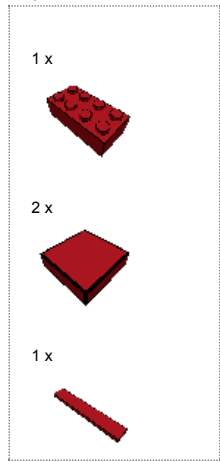

Step 108 of 149

1 x



1 x



1 x



1 x

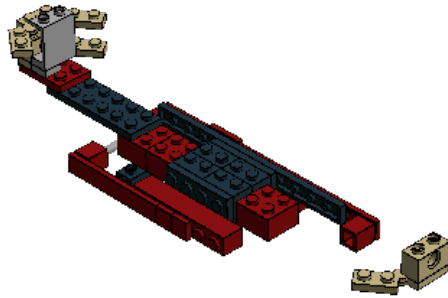

Step 109 of 149

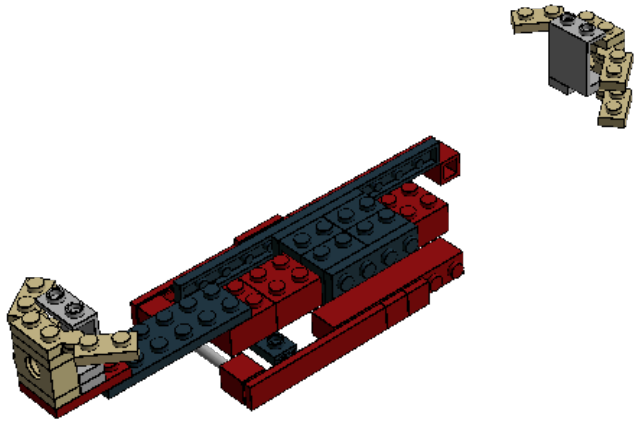
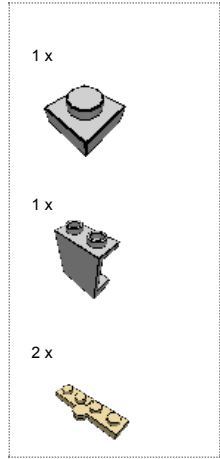

Step 110 of 149

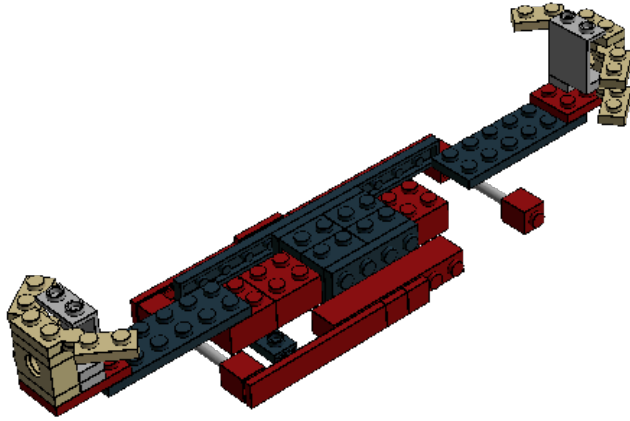
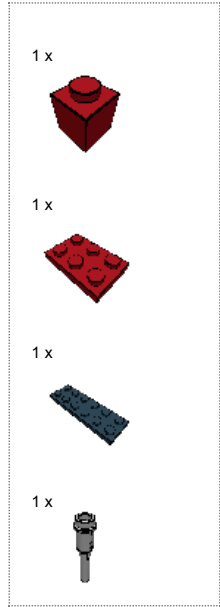

Step 111 of 149

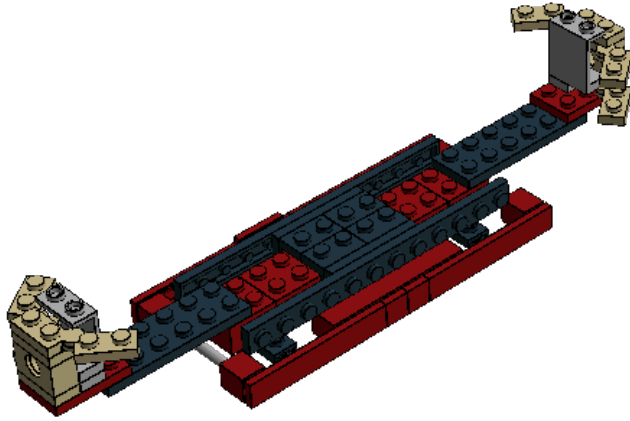
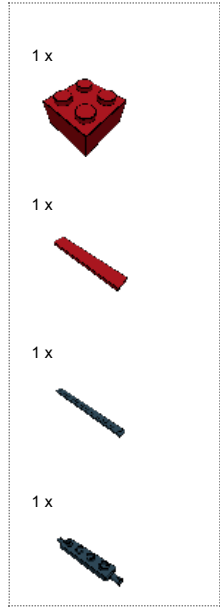

Step 112 of 149

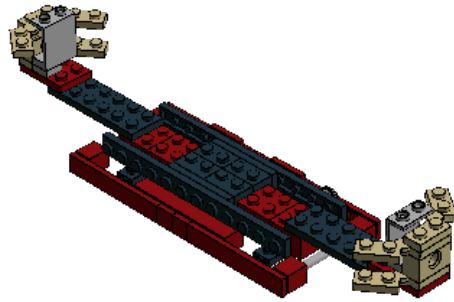
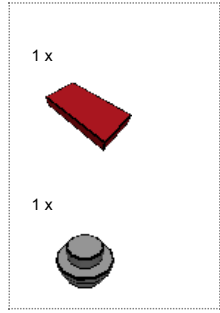

Step 113 of 149

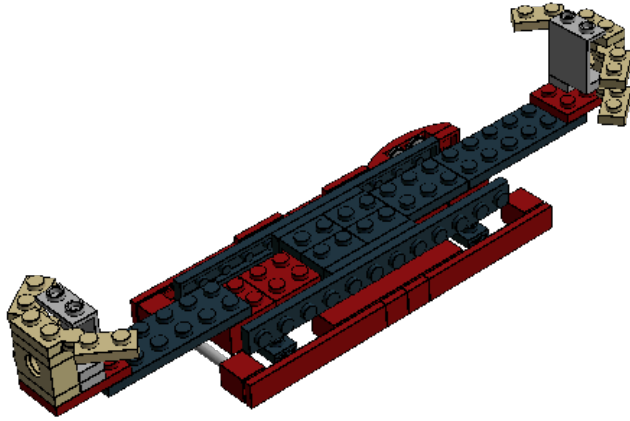
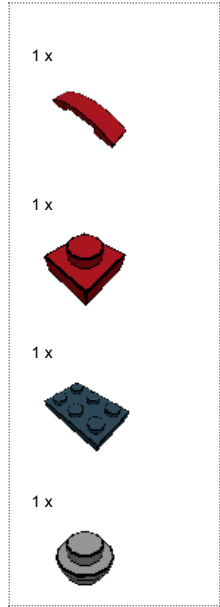

Step 114 of 149

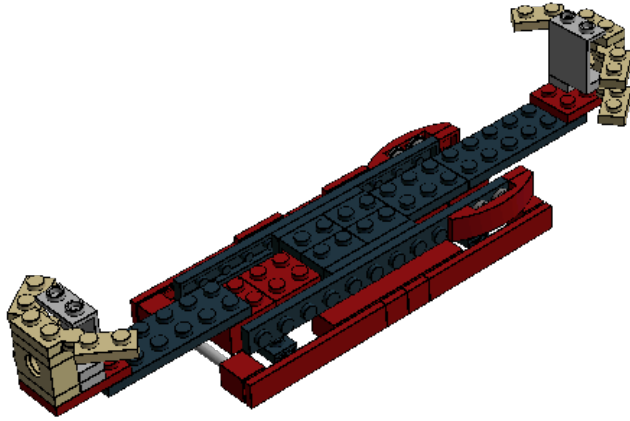
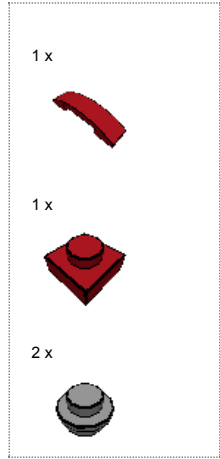

Step 115 of 149

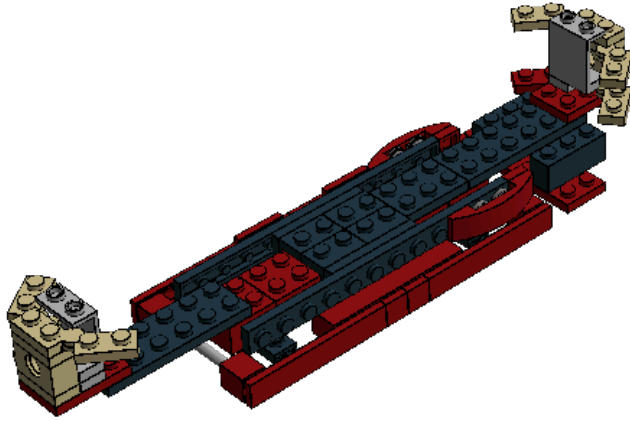
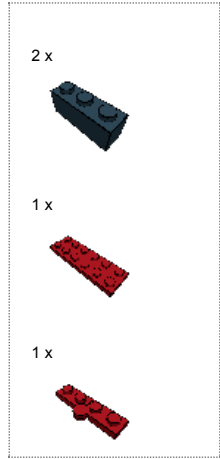

Step 116 of 149

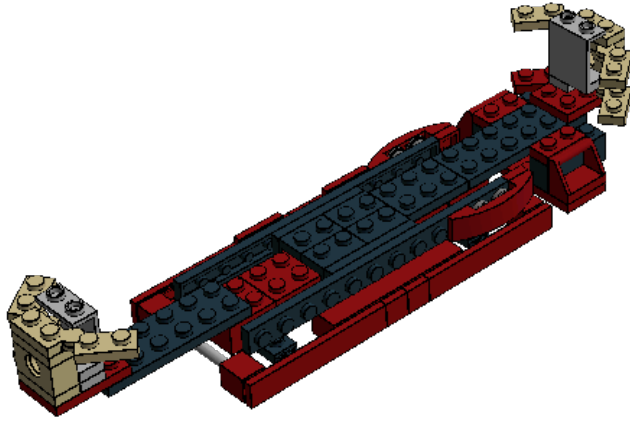
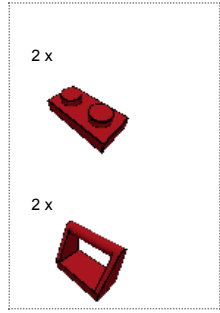

Step 117 of 149

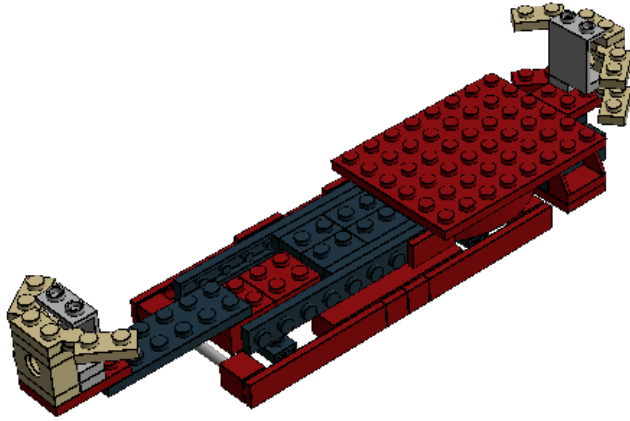
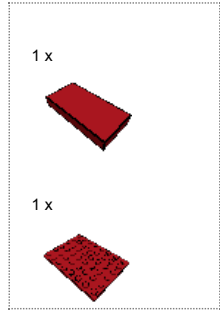

Step 118 of 149

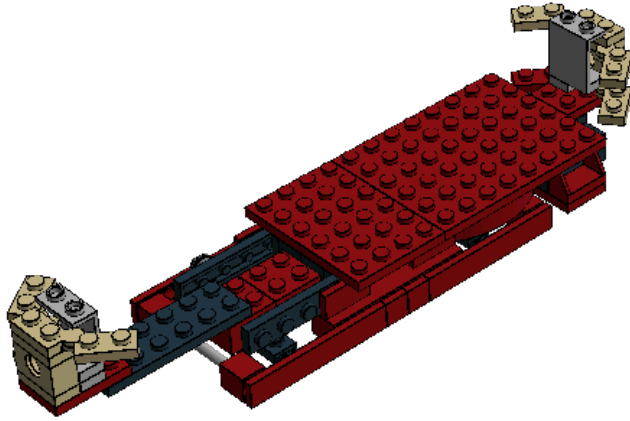
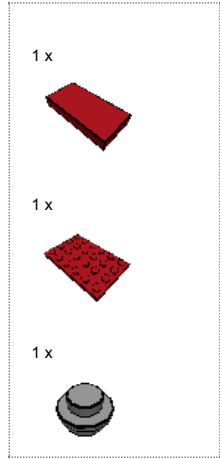

Step 119 of 149

1 x



1 x



1 x



1 x

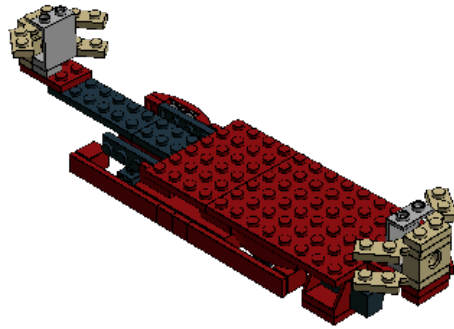

Step 120 of 149

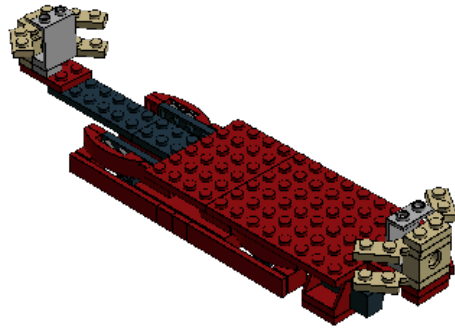
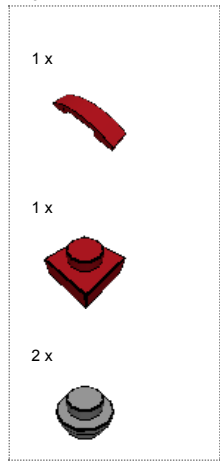

Step 121 of 149

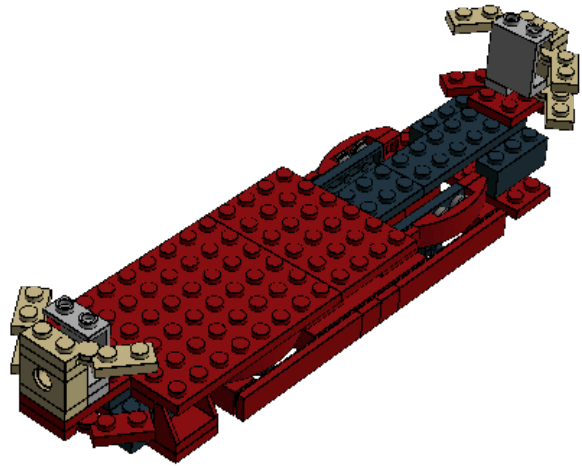
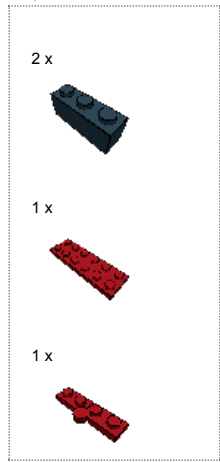

Step 122 of 149

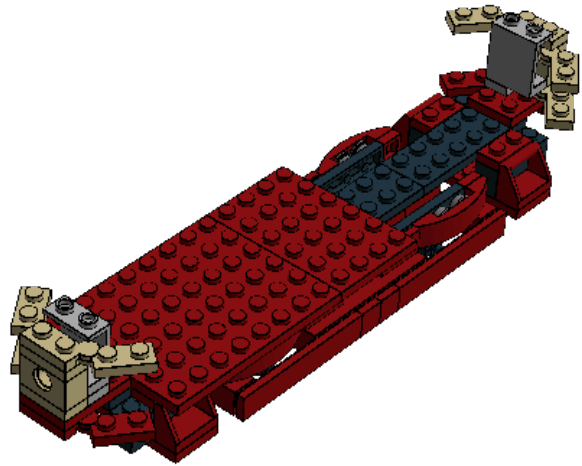
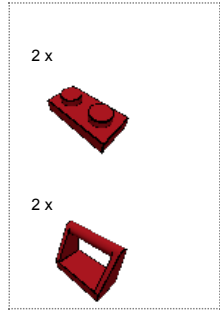

Step 123 of 149

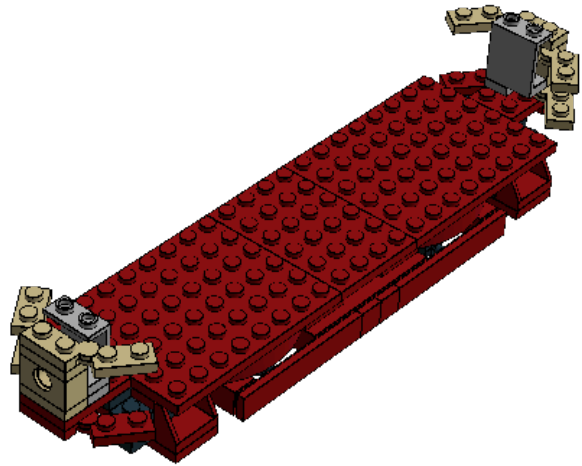
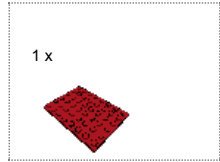

Step 124 of 149

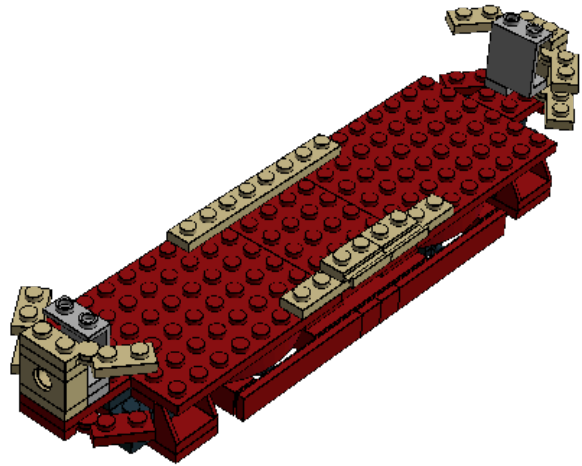
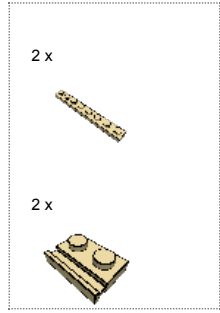

Step 125 of 149

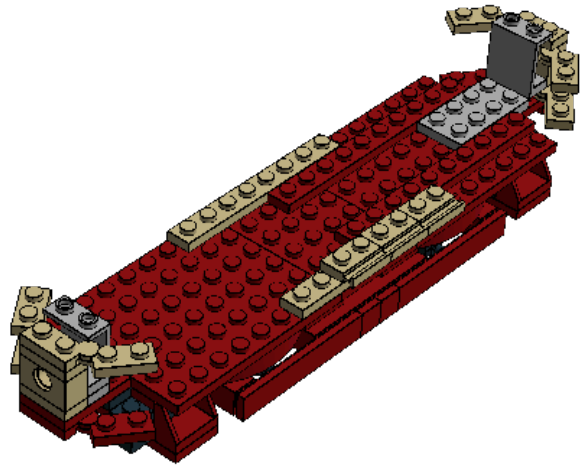
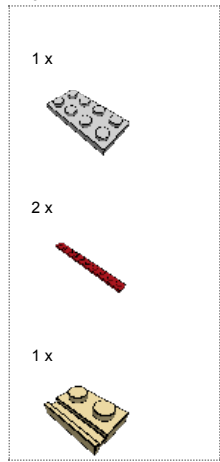

Step 126 of 149

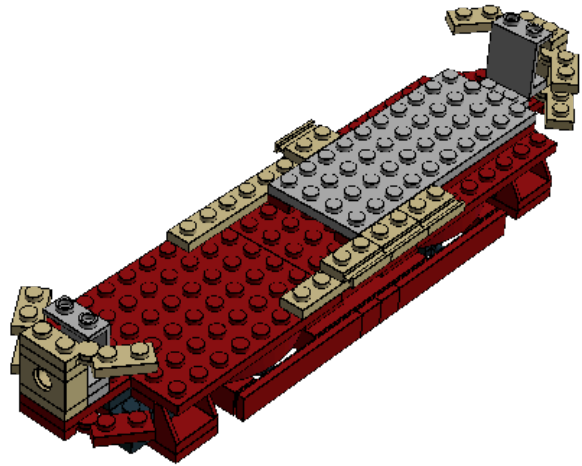
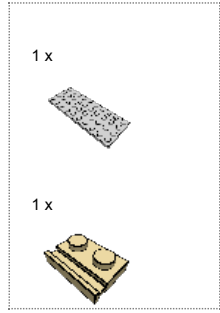

Step 127 of 149

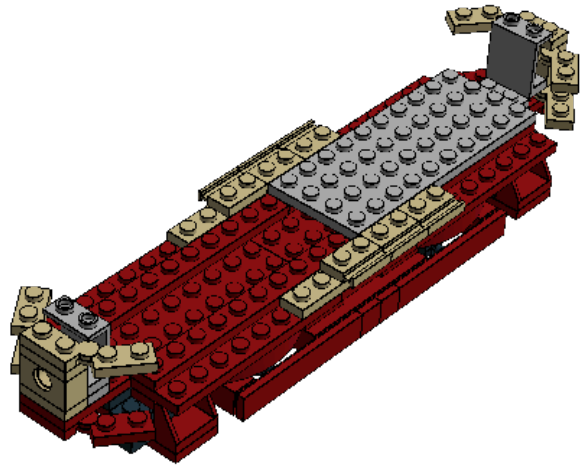
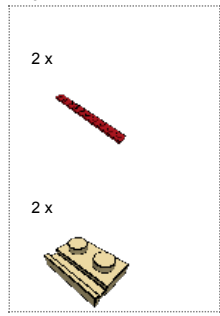

Step 128 of 149

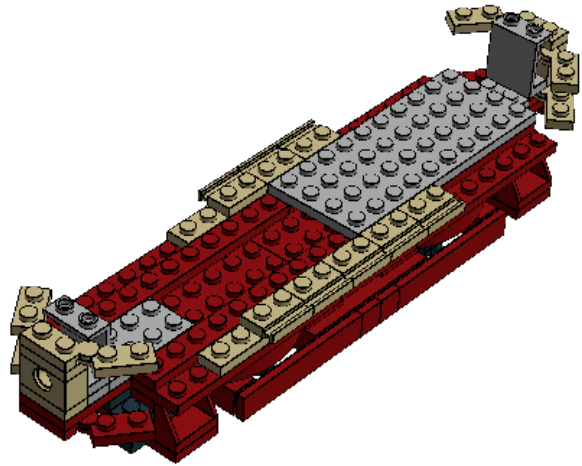
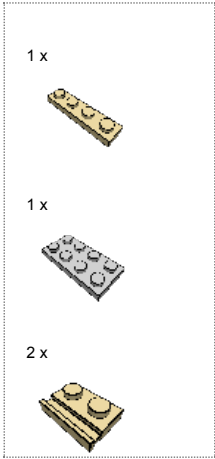

Step 129 of 149

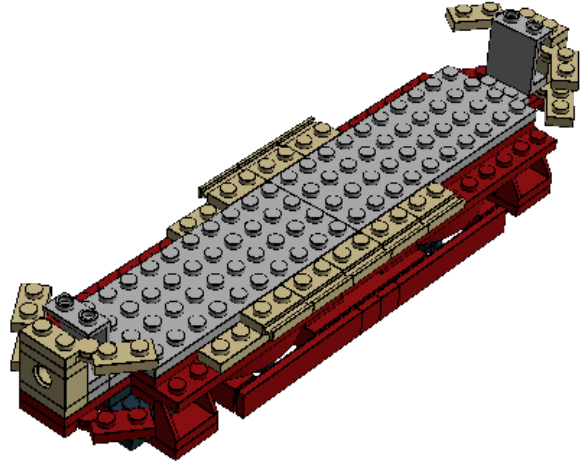
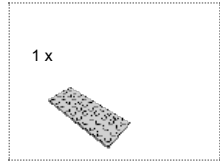

Step 130 of 149

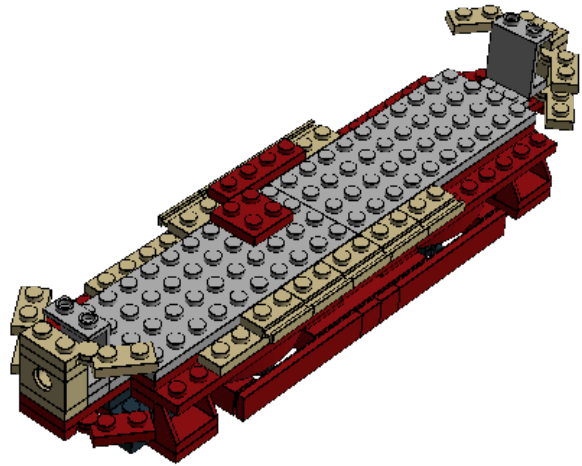
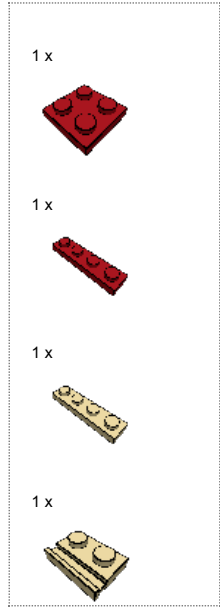

Step 131 of 149

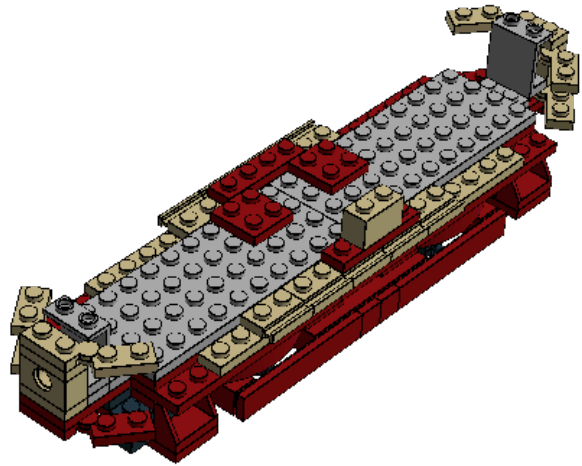
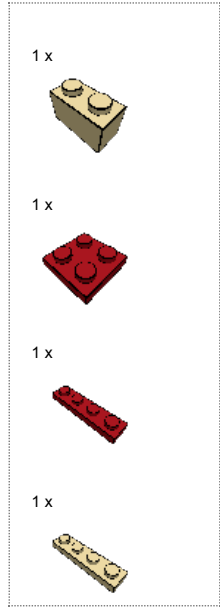

Step 132 of 149

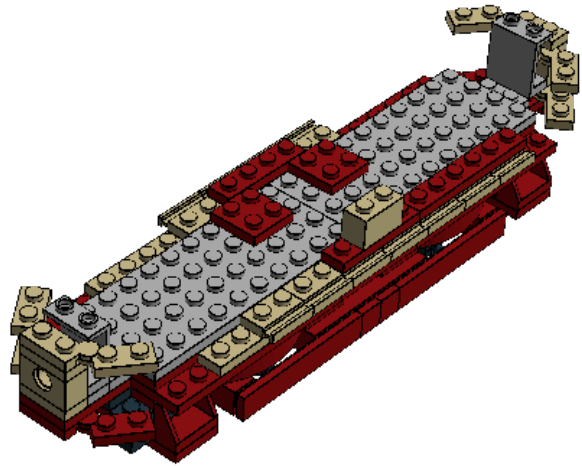
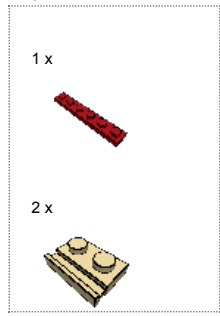

Step 133 of 149

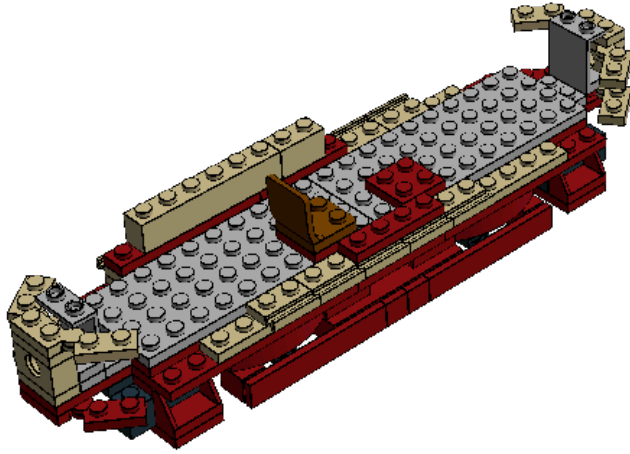
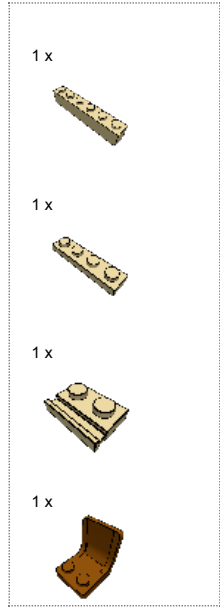

Step 134 of 149

1 x



1 x



1 x



1 x

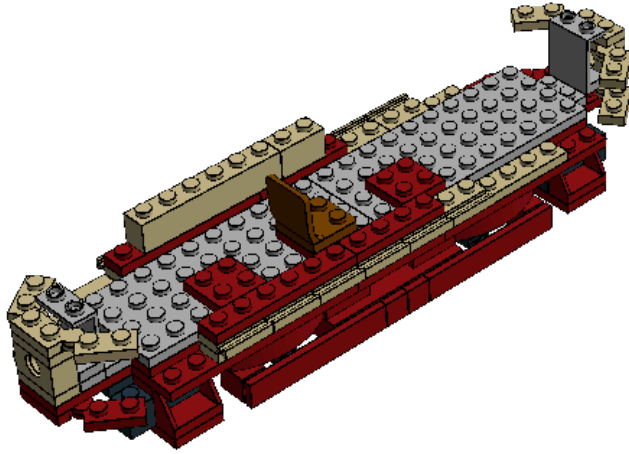

Step 135 of 149

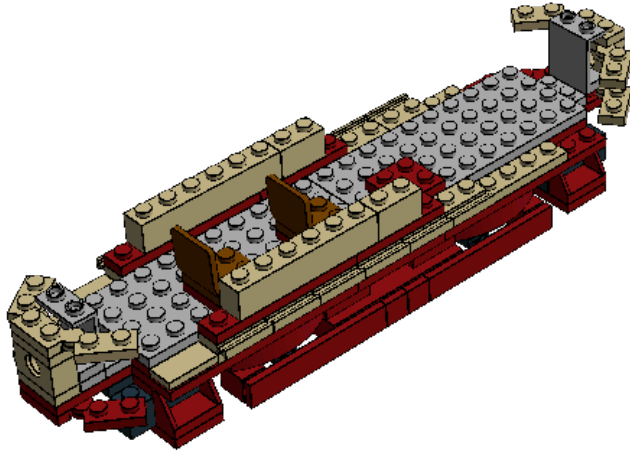
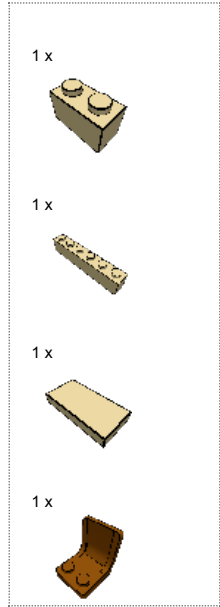

Step 136 of 149

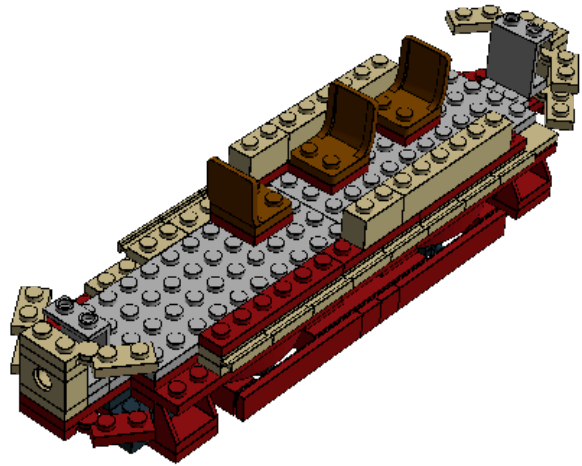
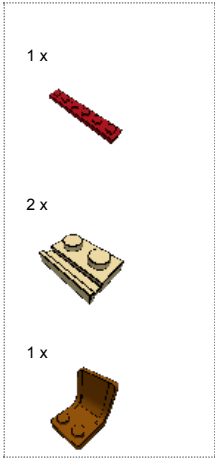

Step 137 of 149

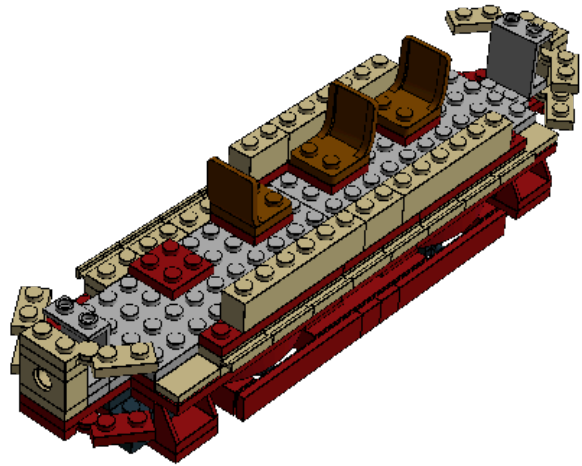
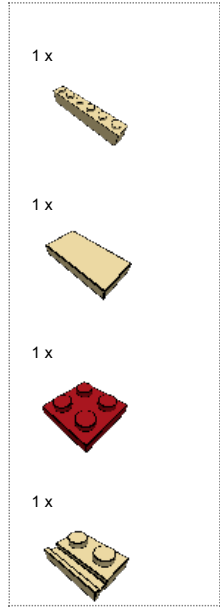

Step 138 of 149

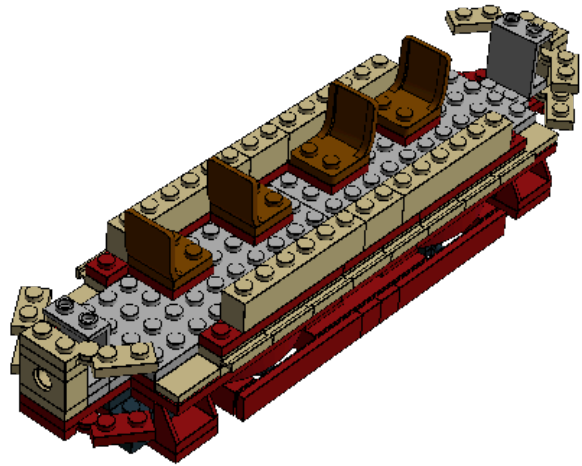
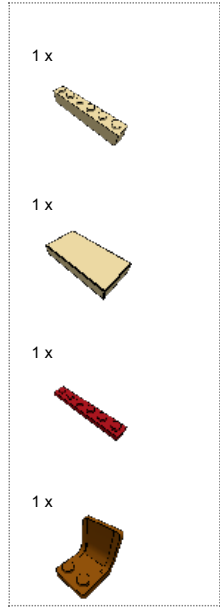

Step 139 of 149

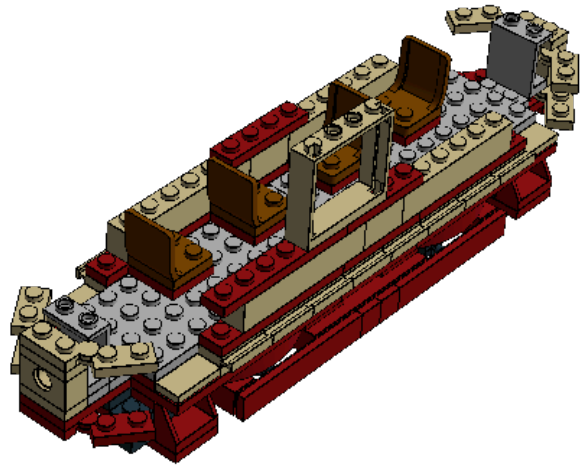
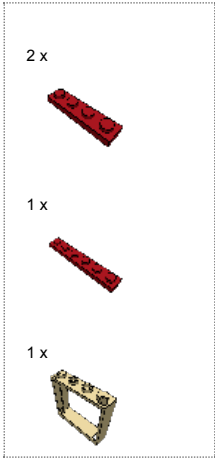

Step 140 of 149

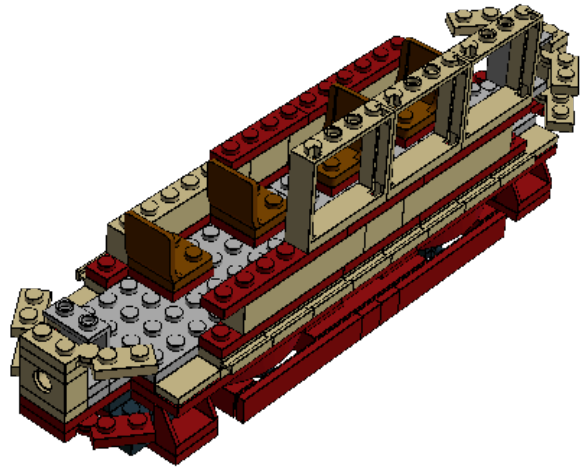
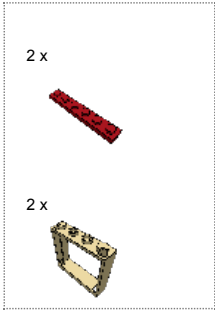

Step 141 of 149

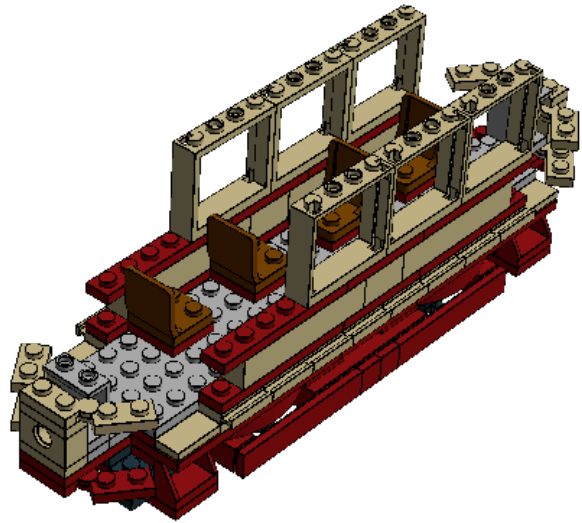
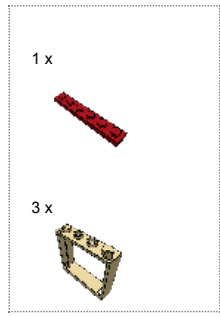

Step 142 of 149

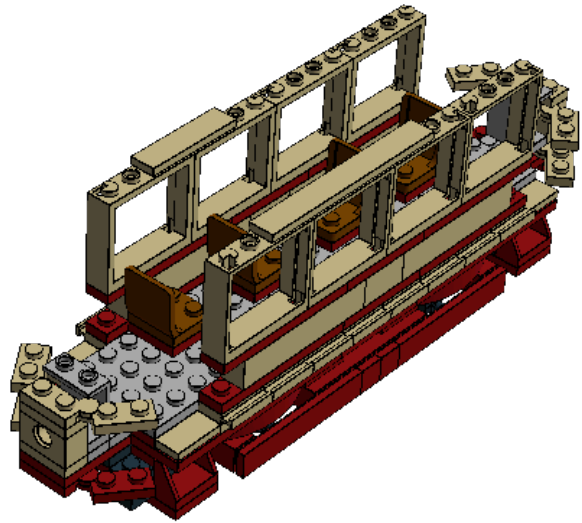
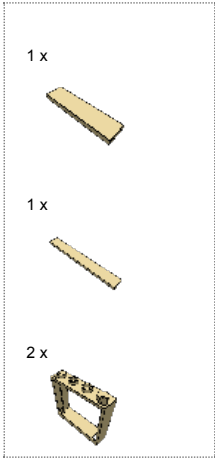

Step 143 of 149

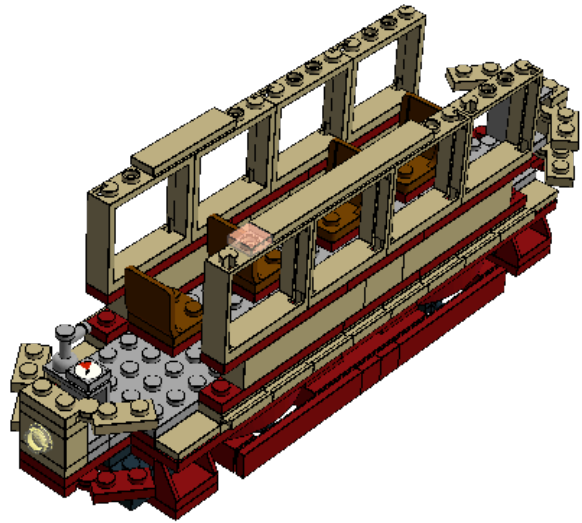
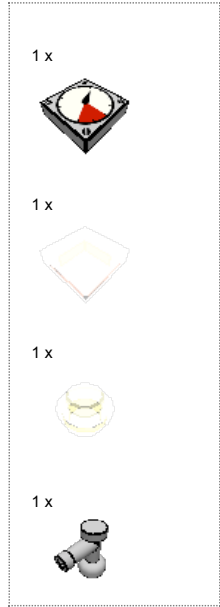

Step 144 of 149

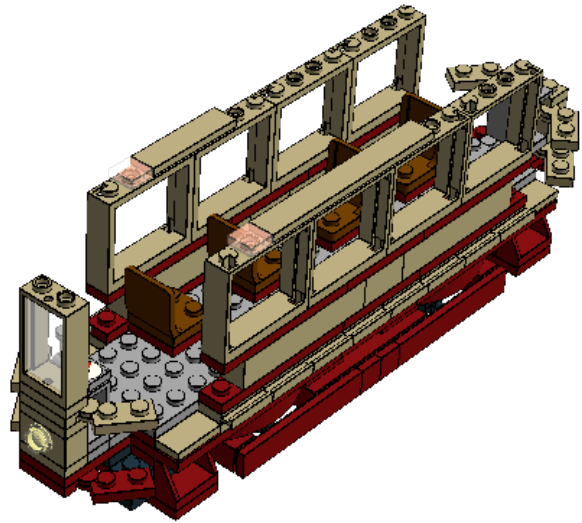
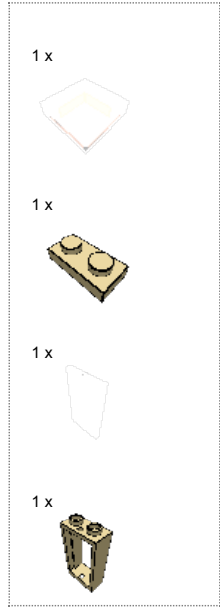

Step 145 of 149

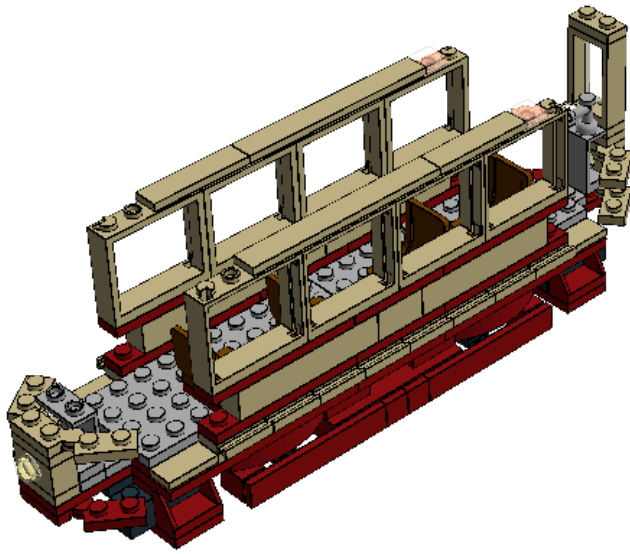
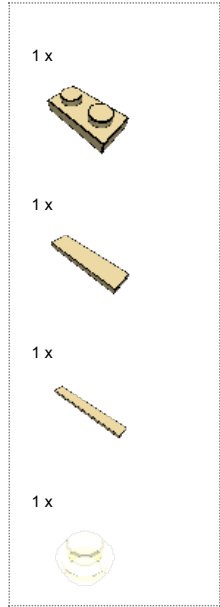

Step 146 of 149

1 x



1 x



1 x



1 x

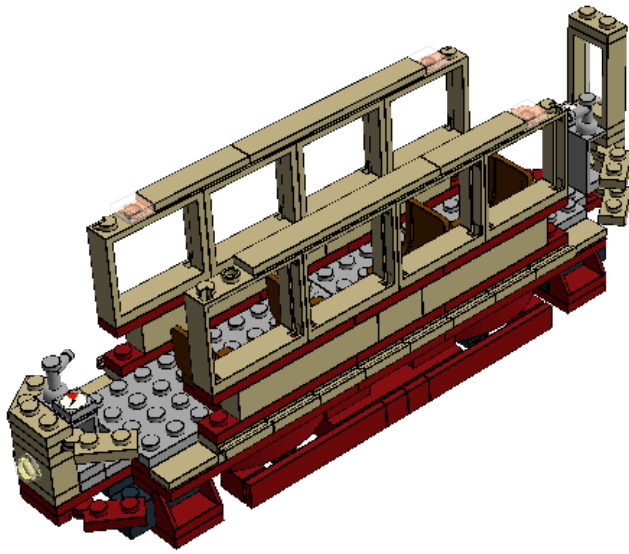

Step 147 of 149

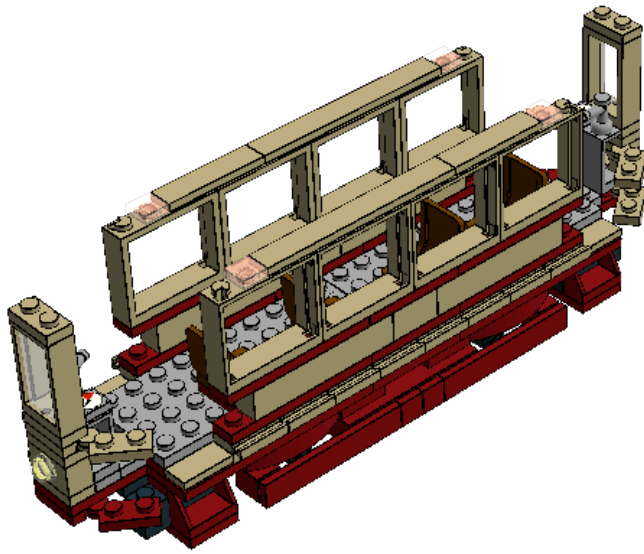
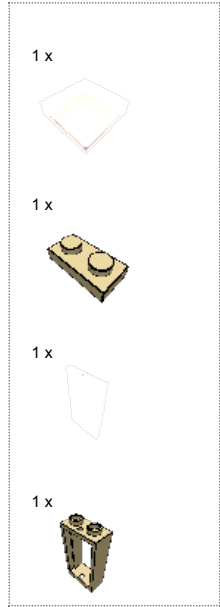

Step 148 of 149

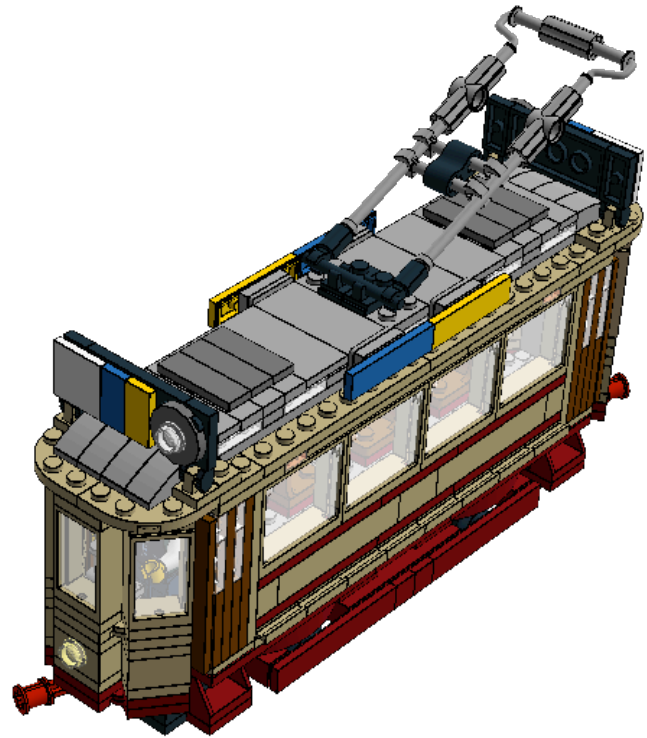

Step 149 of 149

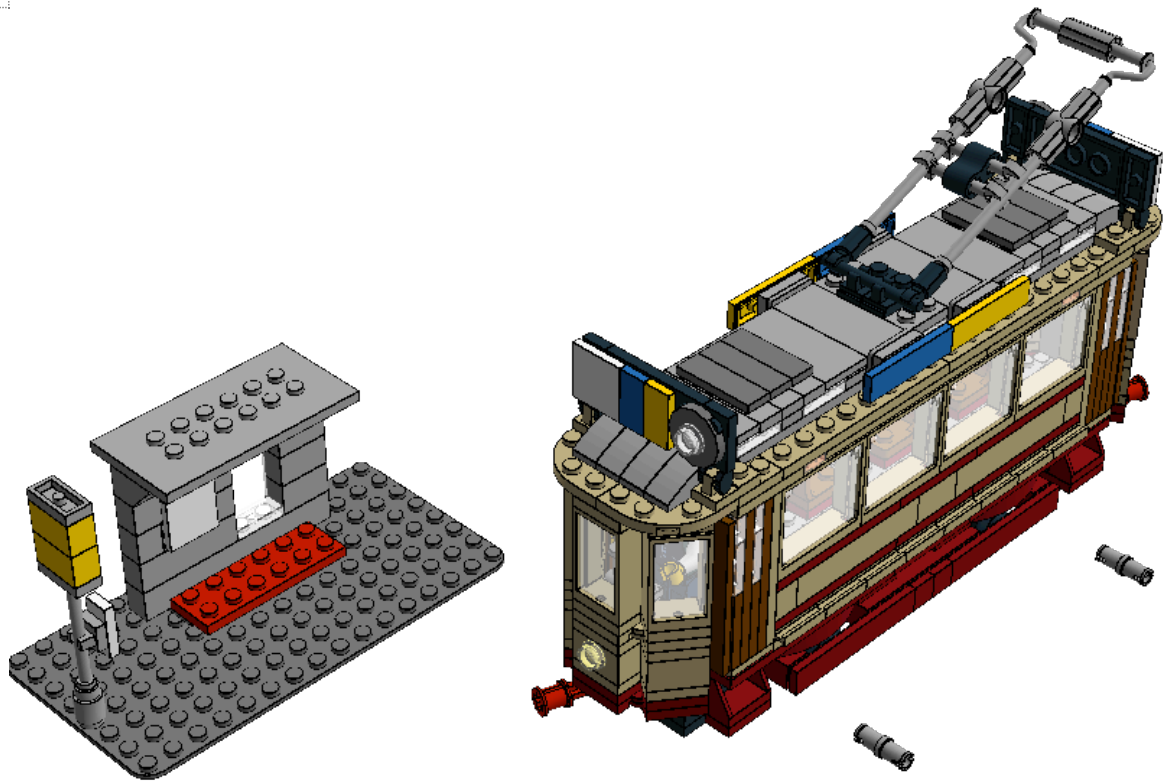



2 x  4211389 BRICK 1X1 - Medium Stone Grey

4 x  4209383 BRICK 1X1 - New Dark Red

4 x  4211388 BRICK 1X2 - Medium Stone Grey

6 x  300405 BRICK 1X2 - Brick Yellow

2 x  300424 BRICK 1X2 - Bright Yellow

4 x  362226 BRICK 1X3 - Black

2 x  4249850 BRICK 2X2 - New Dark Red

2 x  4211394 BRICK 1X4 - Medium Stone Grey

1 x  4211393 BRICK 1X6 - Medium Stone Grey

2 x  4223789 BRICK 1X6 - New Dark Red

4 x  300905 BRICK 1X6 - Brick Yellow

2 x  4163803 BRICK 2X4 - New Dark Red

1 x  4211392 BRICK 1X8 - Medium Stone Grey

1 x  4211412 ROUND BRICK 1X1 - Medium Stone Grey

4 x  4579260 BRICK 1X1 W. 1 KNOB - Brick Yellow

1 x  6015344 BRICK 1X2 W. 2 KNOBS - Medium Stone Grey

2 x  370005 TECHNIC BRICK 1X2, Ø4.9 - Brick Yellow

2 x  4211437 ROOF TILE 1X2 INV. - Medium Stone Grey

2 x  4211817 ROOF TILE CORN. INVERT.2X2/45° - Medium Stone Grey

4 x  6000752 PLATE W. BOW 1X4X2/3 - New Dark Red

8 x  4251163 BRICK W/BOW 1/3 - Medium Stone Grey

2 x  4255629 FLAT TILE 1X1 - Medium Stone Grey

4 x  4187196 FLAT TILE 1X1 - New Dark Red

4 x  4112535 FLAT TILE 1X1 - Tr. Fluore.Redd. Orange

10 x  4211399 PLATE 1X1 - Medium Stone Grey

8 x  302410 PLATE 1X1 - Transparent

4 x  4183901 PLATE 1X1 - New Dark Red

4 x  4165783 FLAT TILE 1X2 - New Dark Red

8 x  306905 FLAT TILE 1X2 - Brick Yellow

2 x  306924 FLAT TILE 1X2 - Bright Yellow

2 x  306923 FLAT TILE 1X2 - Bright Blue





































5 x  4211398 PLATE 1X2 - Medium Stone Grey













18 x  302310 PLATE 1X2 - Transparent

10 x  4162582 PLATE 1X2 - New Dark Red

14 x  302305 PLATE 1X2 - Brick Yellow



13 x  4211451 PLATE 1X2 W. 1 KNOB - Medium Stone Grey

- 1 x  379401 PLATE 1X2 W. 1 KNOB - White
- 6 x  4568734 FLAT TILE 1X3 - Dark Stone Grey
- 2 x  4211356 FLAT TILE 1X4 - Medium Stone Grey
- 2 x  243105 FLAT TILE 1X4 - Brick Yellow
- 2 x  243124 FLAT TILE 1X4 - Bright Yellow
- 2 x  243123 FLAT TILE 1X4 - Bright Blue
- 3 x  306801 FLAT TILE 2X2 - White
- 8 x  4211152 PLATE 1X3 - Reddish Brown
- 4 x  362305 PLATE 1X3 - Brick Yellow
- 4 x  4163160 PLATE 2X2 - New Dark Red
- 2 x  371026 PLATE 1X4 - Black
- 2 x  4211445 PLATE 1X4 - Medium Stone Grey
- 4 x  4164219 PLATE 1X4 - New Dark Red
- 4 x  371005 PLATE 1X4 - Brick Yellow
- 4 x  4163776 FLAT TILE 1X6 - New Dark Red
- 4 x  4211204 FLAT TILE 1X6 - Reddish Brown
- 2 x  416205 FLAT TILE 1X8 - Brick Yellow
- 4 x  4560183 FLAT TILE 2X4 - Medium Stone Grey
- 2 x  302126 PLATE 2X3 - Black
- 2 x  4177047 PLATE 2X3 - New Dark Red
- 6 x  4211438 PLATE 1X6 - Medium Stone Grey
- 8 x  4164108 PLATE 1X6 - New Dark Red
- 8 x  4221590 PLATE 1X6 - Reddish Brown
- 4 x  366605 PLATE 1X6 - Brick Yellow
- 4 x  302026 PLATE 2X4 - Black
- 3 x  4211395 PLATE 2X4 - Medium Stone Grey
- 2 x  346005 PLATE 1X8 - Brick Yellow
- 4 x  6037995 PLATE 1X10 - New Dark Red
- 2 x  379526 PLATE 2X6 - Black
- 2 x  4164177 PLATE 2X6 - New Dark Red
- 1 x  379521 PLATE 2X6 - Bright Red
- 2 x  379505 PLATE 2X6 - Brick Yellow
- 2 x  4514845 PLATE 1X12 - Black
- 4 x  303405 PLATE 2X8 - Brick Yellow
- 1 x  4167304 PLATE 4X6 - New Dark Red
- 1 x  4215405 PLATE 4X8 W. 12 KNOBS - Medium Stone Grey



- 2 x  4211402 PLATE 4X10 - Medium Stone Grey
- 2 x  6028115 PLATE 6X8 - New Dark Red
- 8 x  4210633 PLATE 1X1 ROUND - Dark Stone Grey
- 2 x  614140 PLATE 1X1 ROUND - Transparent
- 2 x  614144 PLATE 1X1 ROUND - Tr. Yellow
- 2 x  6055313 FLAT TILE 2x2 ROUND W. HOLE Ø4.85 - Dark Stone Grey
- 4 x  4124071 PLATE 3X3, 1/4 CIRCLE - Brick Yellow
- 1 x  4211369 PLATE 1X1 W. UP RIGHT HOLDER - Medium Stone Grey
- 4 x  4183060 PLATE 1X2 W/FORK/VERTICAL/END - Black
- 16 x  4160483 PLATE 1X2 WITH SLIDE - Brick Yellow
- 2 x  4598528 PLATE 1X2 W. VERTICAL GRIP - Black
- 4 x  4129974 PLATE 1X2 W/STUB/ALONG/UPPER P - Brick Yellow
- 4 x  4654581 ANGULAR PLATE 1.5 BOT. 1X2 1/2 - Medium Stone Grey
- 4 x  4163461 CLAMP 1X2 - New Dark Red
- 4 x  4184645 ANGLE PLATE 1X2 / 2X2 - Black
- 6 x  4536998 GLASS FOR FRAME 1X2X3 - Transparent
- 8 x  4521279 GLASS FOR FRAME 1X4X3 - Transparent
- 2 x  4211576 WALLELEMENT 1X2X2 - Medium Stone Grey
- 1 x  4100381 WALL ELEMENT 1X2X3 - Transparent
- 6 x  6034929 FRAME 1X2X3 - Brick Yellow
- 8 x  4578109 FRAME 1X4X3 - Brick Yellow
- 2 x  292626 BEARING PLATE 1X4, DOUBLE - Black
- 2 x  4143005 CONNECTOR PEG W. KNOB - Bright Blue
- 2 x  4211807 CONNECTOR PEG - Medium Stone Grey
- 2 x  4227155 BUSH FOR CROSS AXLE - Bright Red
- 2 x  4143851 CROSS AXLE 4M - Bright Red
- 1 x  4512360 CROSS AXLE, EXTENSION, 2M - Medium Stone Grey
- 1 x  4198367 DAMPER 2M - Black
- 2 x  4260023 ANGLE ELEMENT, 0 DEGREES [1] - New Dark Red
- 2 x  4211567 ANGLE ELEMENT, 180 DEGREES [2] - Medium Stone Grey
- 1 x  4226978 BASE PLATE 8X16 - Dark Stone Grey
- 1 x  4140303 LIGHT SWORD - BLADE - Black
- 2 x  4211628 LIGHT SWORD - BLADE - Medium Stone Grey
- 4 x  4222045 STICK Ø 3.2 W. HOLDER - Medium Stone Grey
- 2 x  6015891 HOLDER Ø3.2 W/TUBE Ø3.2 HOLE - Black
- 2 x  4211503 TAP Ø4.9/6.4 - Medium Stone Grey

- 2 x  4520320 3 w.arch w.knob and shaft
ø3.2 - Medium Stone Grey



2 x  4211887 STANDARD Ø3.18 X 53 -
Medium Stone Grey

1 x  4211473 STICK/AERIAL - Medium
Stone Grey
- 4 x  4211206 SEAT 2X2X2 - Reddish
Brown



4 x  4227006 TRAINWHEEL Ø8.2/14.6 -
Black

2 x  4224503 HINGE PLATE 1X2 - New
Dark Red
- 6 x  4143329 HINGE PLATE 1X2 - Brick
Yellow

1 x  4162916 MINI LOWER PART - Earth
Blue

1 x  4275535 MINI UPPER PART -
White,Bright Yellow,Black
- 1 x  4245646 MINI HEAD - Bright Yellow

1 x  4255628 MINI CAP - Earth Blue

2 x  4657366 STICK Ø3.2 2MM W/KNOB
AND TUBE - Medium Stone
Grey
- 2 x  6033994 PAINT ROLLER W. Ø3.2
SHAFT - Medium Stone
Grey

© 2012 The LEGO Group. All rights reserved.
Use of the LEGO Digital Designer html print tool, signifies your agreement to the terms of use.